

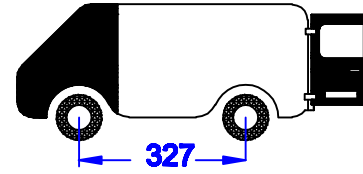

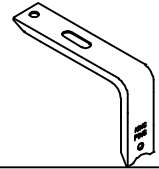





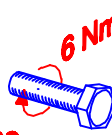

**Citroën Jumpy** TYPE M 2016  
**Peugeot Expert** STANDAARD 2016  
**Toyota Pro Ace** WORKER 2016

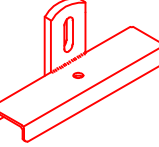
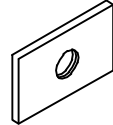

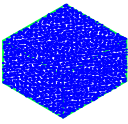
**280x141cm. L2 H1**

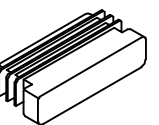
 <b>8x</b>	 <b>24x</b> M8x20	 <b>6x</b> M6x20	 <b>1x</b>
 <b>8x</b>	 <b>24x</b> M8	 * <b>6x</b> M6	
 <b>16x</b>	 <b>16x</b> 3xD M8	 * <b>6x</b> 2xD M6	
 <b>8x</b>	 <b>24x</b> M8	 * <b>6x</b> M6	



- Bij onduidelijkheden raadpleeg uw leverancier!
- Might this not be clear, please contact your supplier!
- Bei eventuellen Unklarheiten, bitten wir Sie mit Ihren Lieferanten Kontakt aufzunehmen!
- Pour plus de renseignements consultez votre fournisseur!

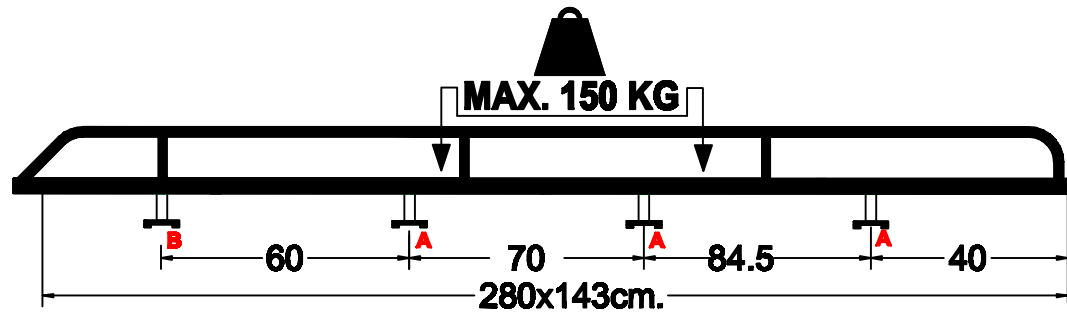

2806 PEL2H1D / CJL2H1D / TPL2H1D 12/09/2016

