

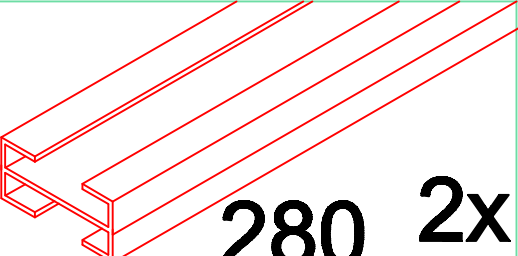

CRAFTER / SPRINTER 06 L2H2

 16x	 280 2x	 16x M8 30X20X25
 16x	 16x M8 2xD	 www.kingping.NL info@kingping.NL

KING PING[®]
www.kingping.NL
info@kingping.NL

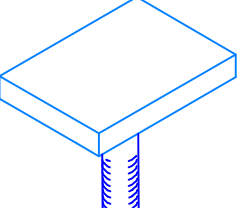
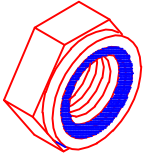
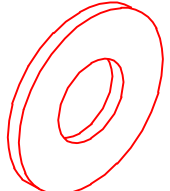

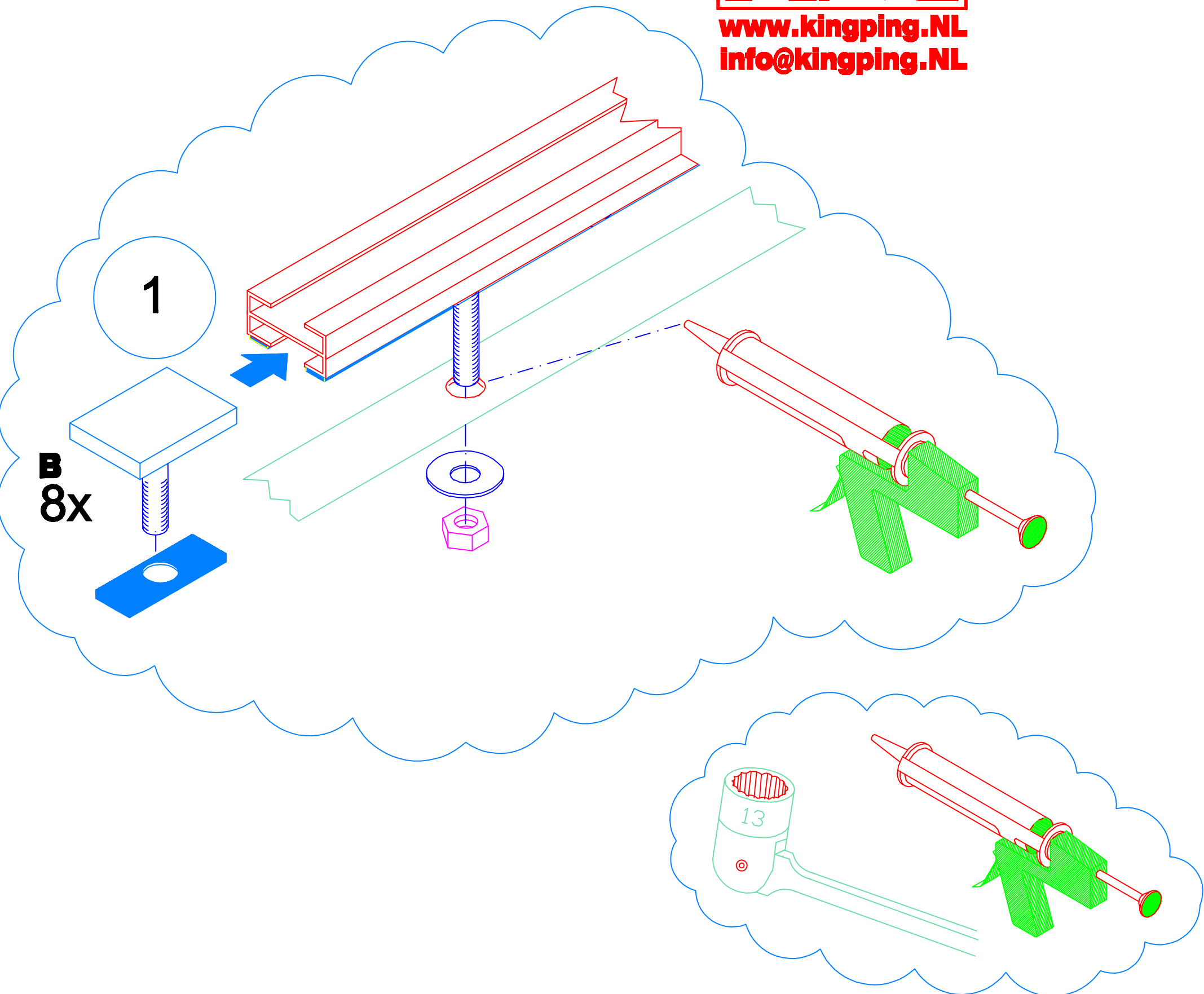
- Bij onduidelijkheden raadpleeg uw leverancier!
- Pour plus de renseignements consultez votre fournisseur!
- Bei eventuellen Unklarheiten, bitten wir Sie mit Ihren Lieferanten Kontakt aufzunehmen!
- Might this not be clear, please contact your supplier!