

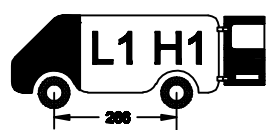

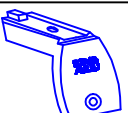



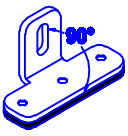

FORD TRANSIT CONNECT 2014

200x143 cm.



 6x	 6x	 6x
S	M8x25	M6x25 <small>Max. 20Nm</small>
 6x	 12x	 6x
M8		M6
 12x	 6x	
2xD M8	M6 F	
 6x		
3xD M6		

KING ALU www.kingping.nl
 Email: info@kingping.nl



MONTAGEFILM KING-ALU IMPERIAAL

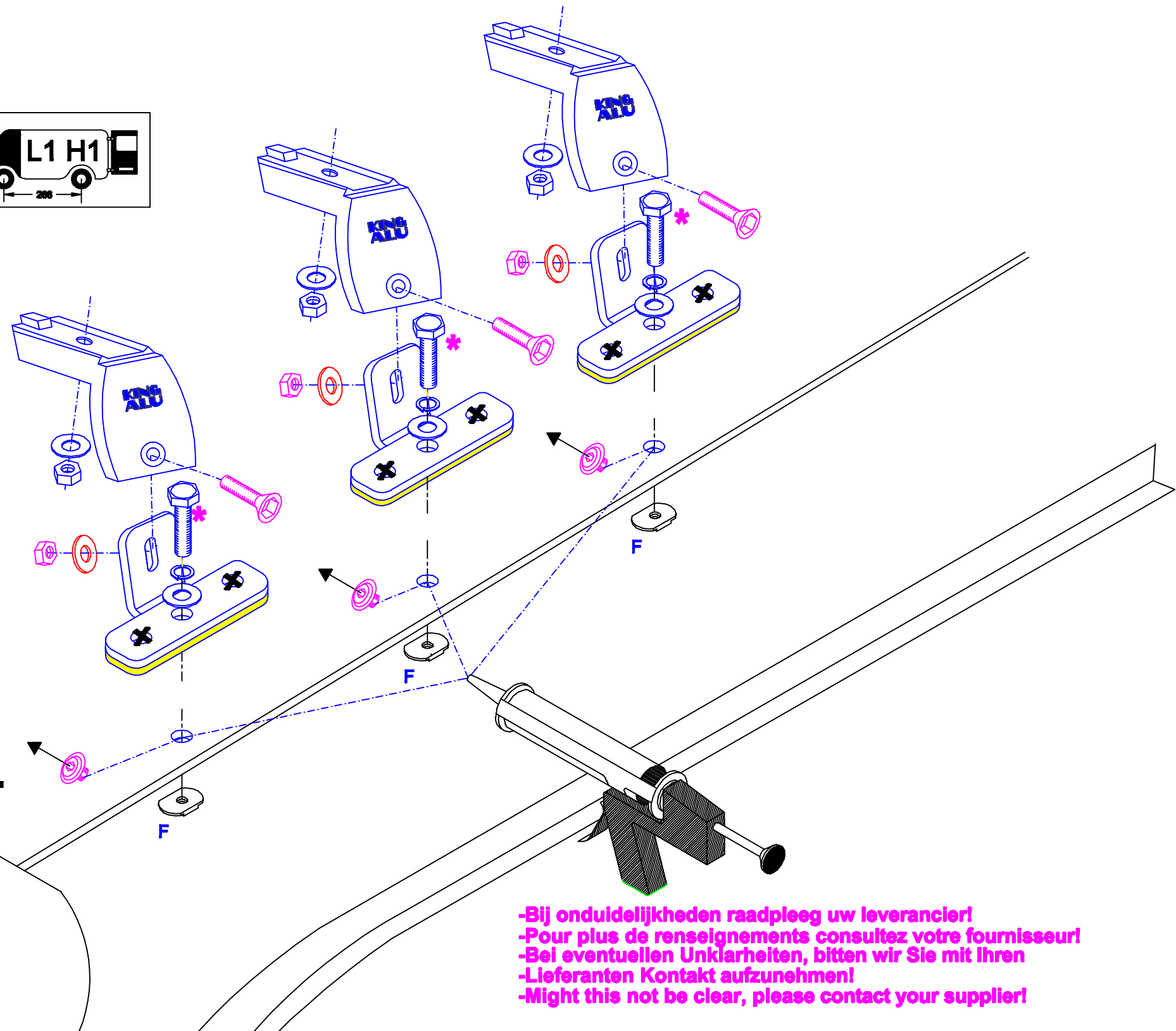
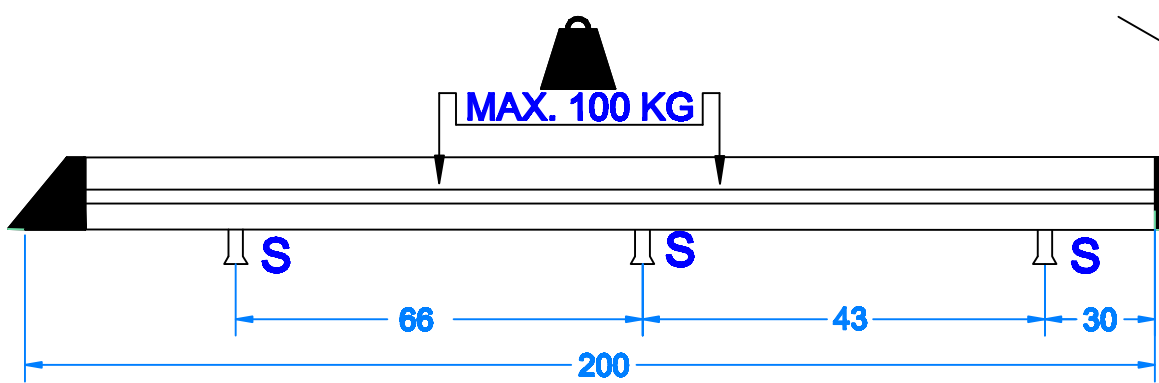





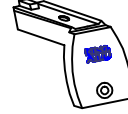

-Bij onduidelijkheden raadpleeg uw leverancier!
 -Pour plus de renseignements consultez votre fournisseur!
 -Bei eventuellen Unklarheiten, bitten wir Sie mit Ihren
 -Lieferanten Kontakt aufzunehmen!
 -Might this not be clear, please contact your supplier!

FORD TRANSIT CONNECT

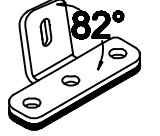
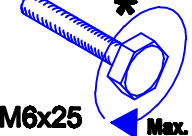
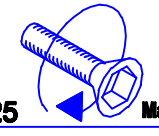
220x143 cm. 2014 met deuren

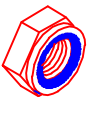

S		6x		6x
			M6 3xD	
		6x		6x
			M6x25	Max. 6Nm
		6x		6x
			M6x25	Max. 13Nm
M8		12x	M6 F	6x
			M6	
		12x		
			M6	
		12x		
			M8 2xD	

KING www.kingping.nl
ALU Email: info@kingping.nl

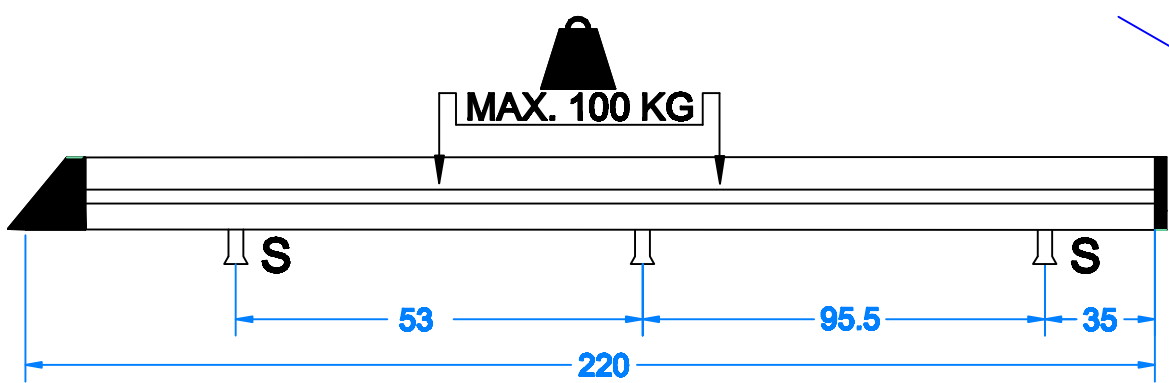
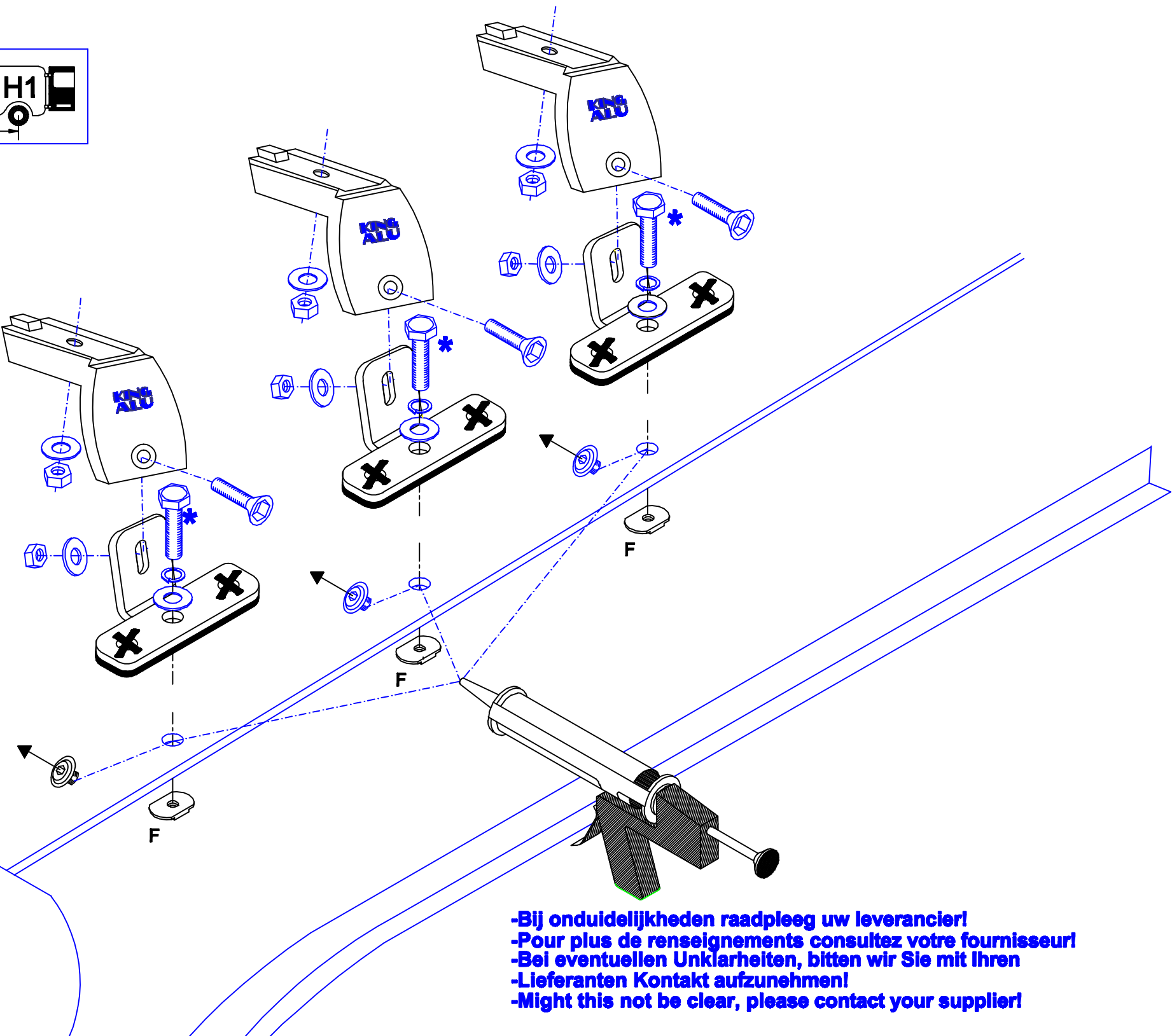

-Bij onduidelijkheden raadpleeg uw leverancier!
-Pour plus de renseignements consultez votre fournisseur!
-Bei eventuellen Unklarheiten, bitten wir Sie mit Ihren
-Lieferanten Kontakt aufzunehmen!
-Might this not be clear, please contact your supplier!