

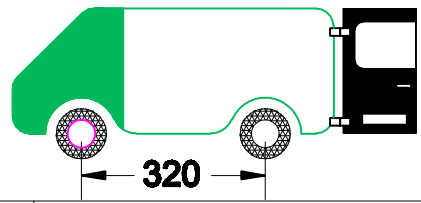

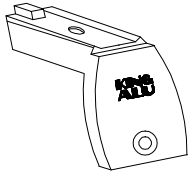



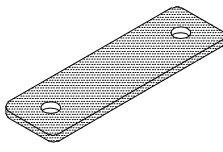
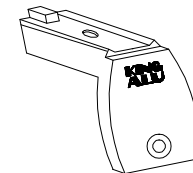
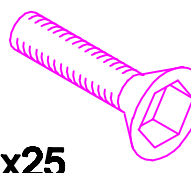
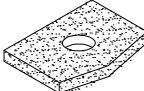
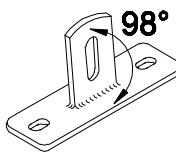
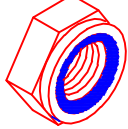

Mercedes Vito

280x143 cm. L1 H1

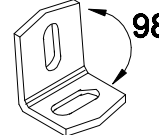

| | | | |
|---|--|--|--|
| S |  4x |  16x |  6x |
| P |  4x |  8x |  2x |
|  6x |  16x |  14x | |
|  2x |  14x | | |
|  14x |  14x | | |



MONTAGEFILM KING-ALU IMPERIAAL

MAX. 150 KG

www.king-ping.com

info@king-ping.com

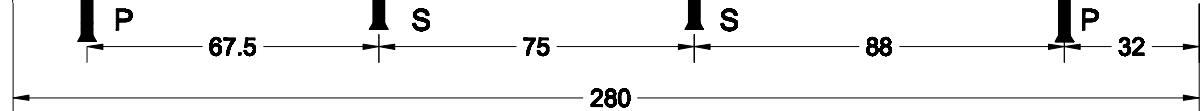

www.kingping.nl
info@kingping.nl

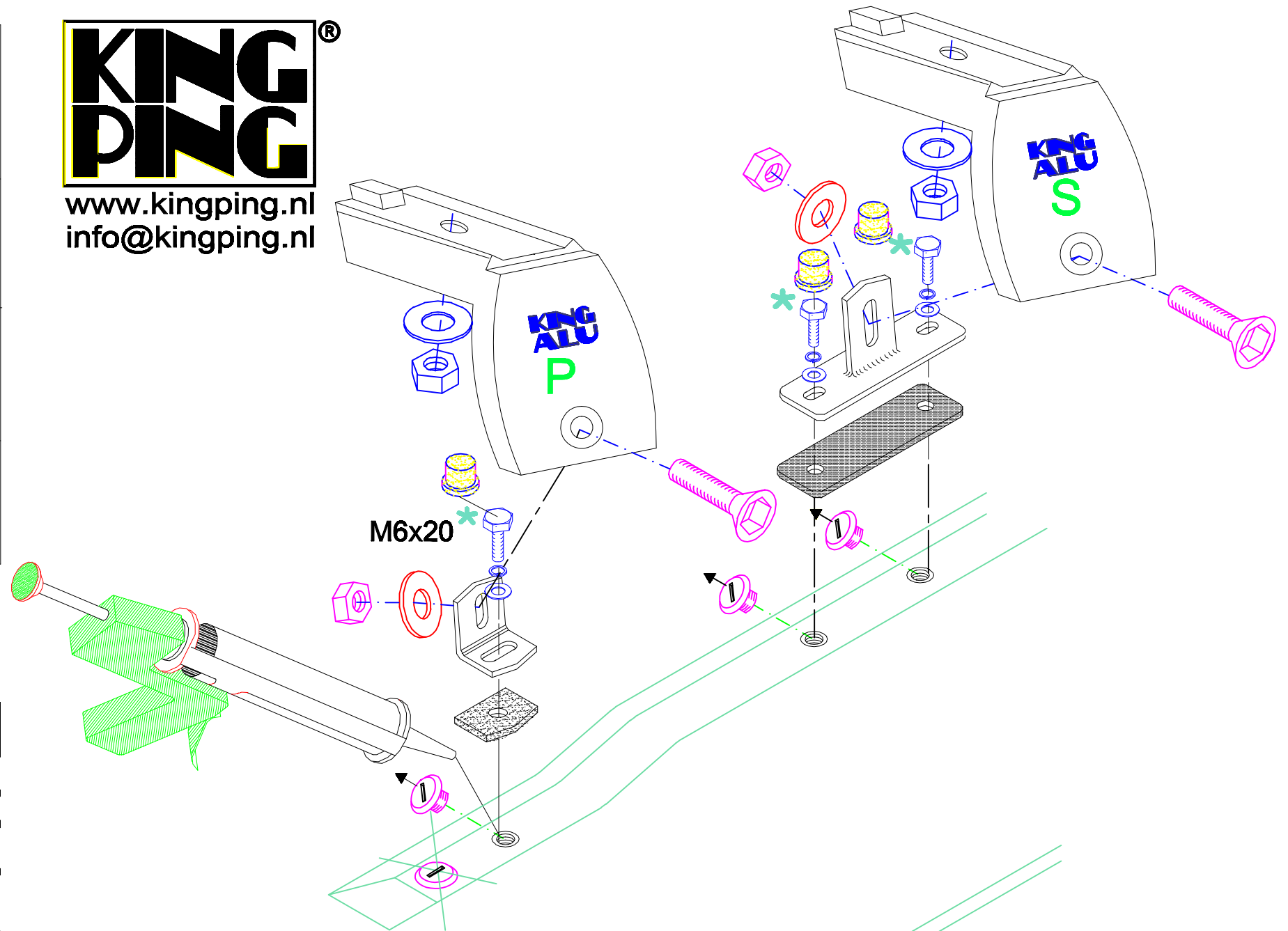

- Bij onduidelijkheden raadpleeg uw leverancier!
- Might this not be clear, please contact your supplier!
- Bei eventuellen Unklarheiten, bitten wir Sie mit Ihren Lieferanten Kontakt aufzunehmen!
- Pour plus de renseignements consultez votre fournisseur!

Mercedes Vito

250x143 cm. L1 H1

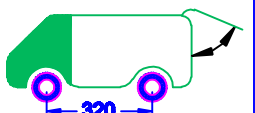

| | | |
|----|-----|-----|
| 4x | 8x | 6x |
| 4x | 8x | * |
| 4x | 16x | 14x |
| 6x | * | * |
| 1x | 1x | |



-Bij onduidelijkheden raadpleeg uw leverancier!
 -Might this not be clear, please contact your supplier!
 -Bei eventuellen Unklarheiten, bitten wir Sie mit Ihren Lieferanten Kontakt aufzunehmen!
 -Pour plus de renseignements consultez votre fournisseur!

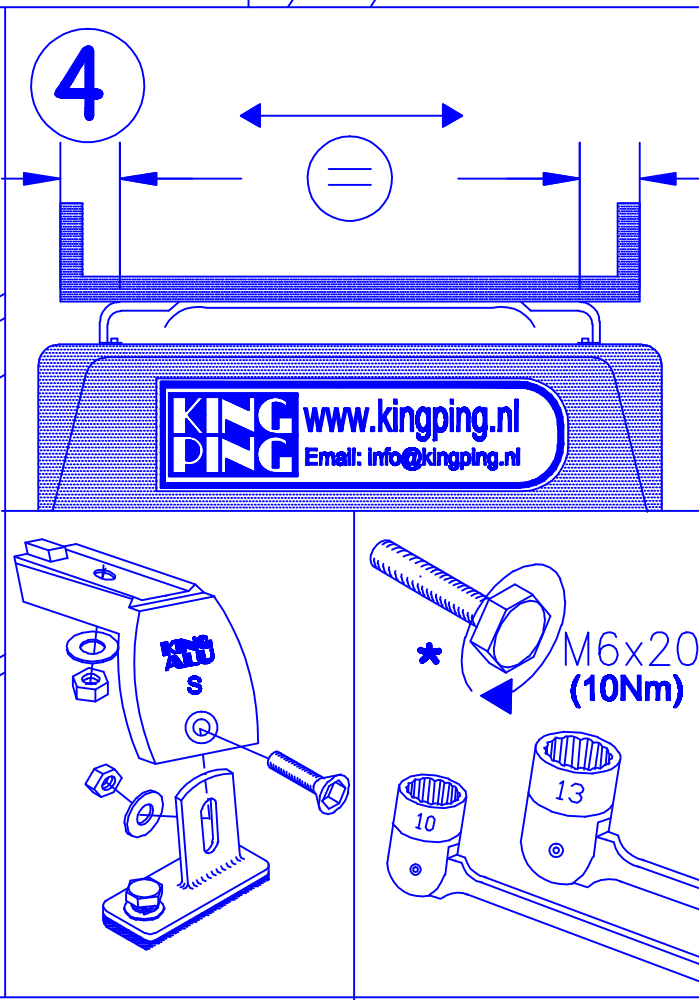
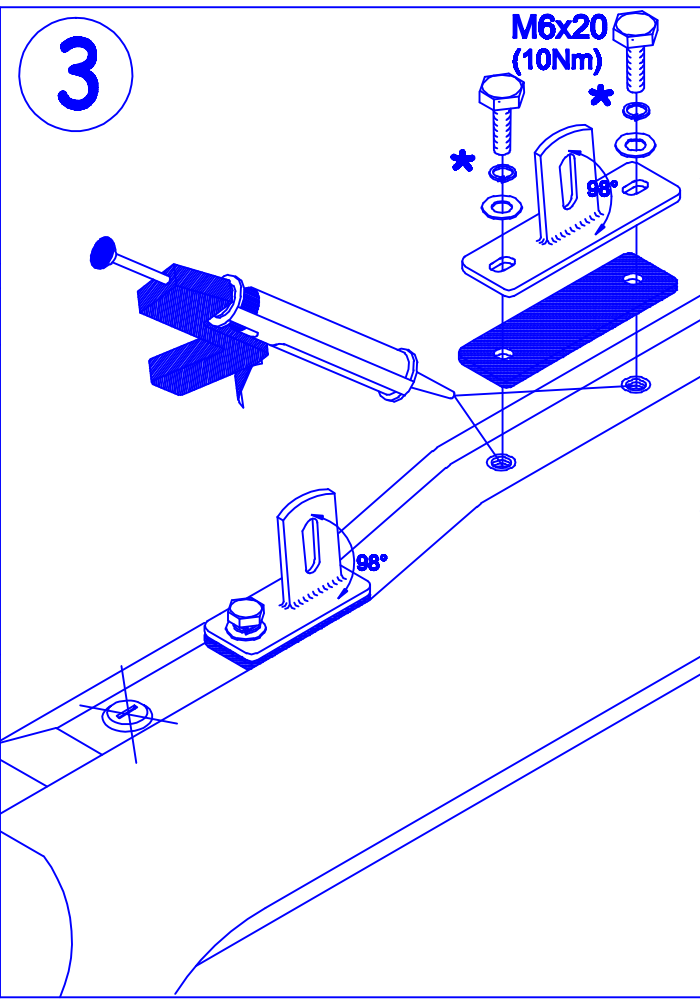
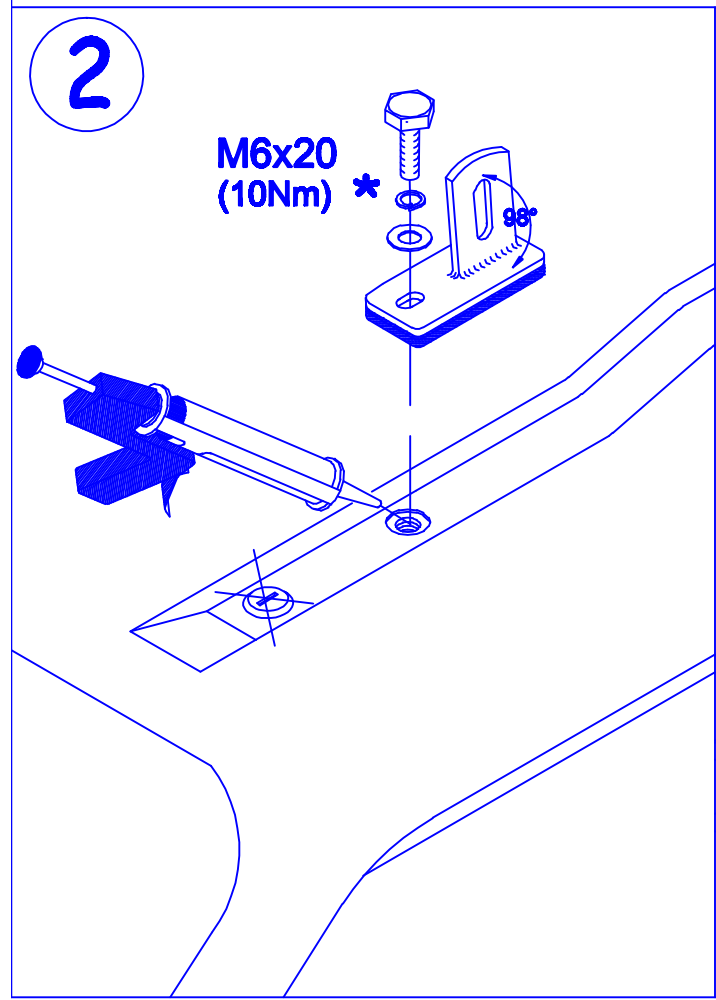
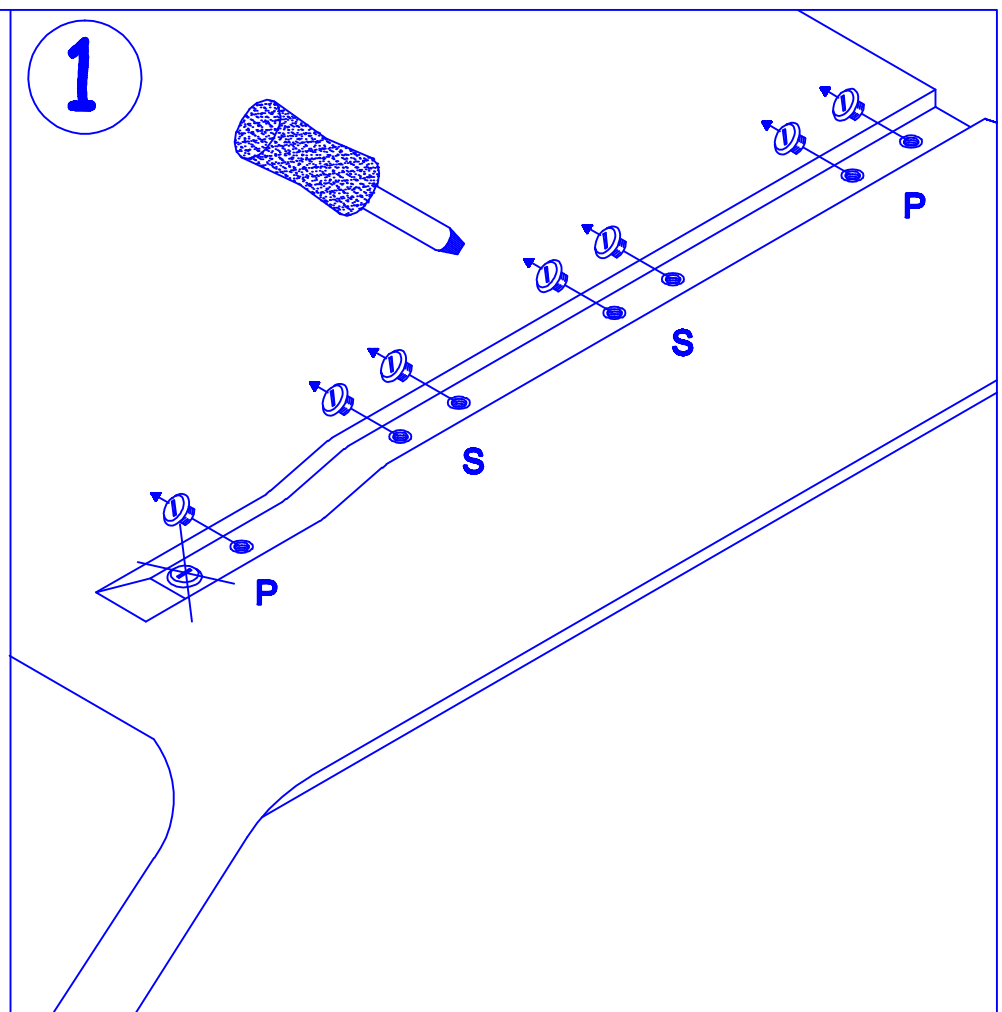
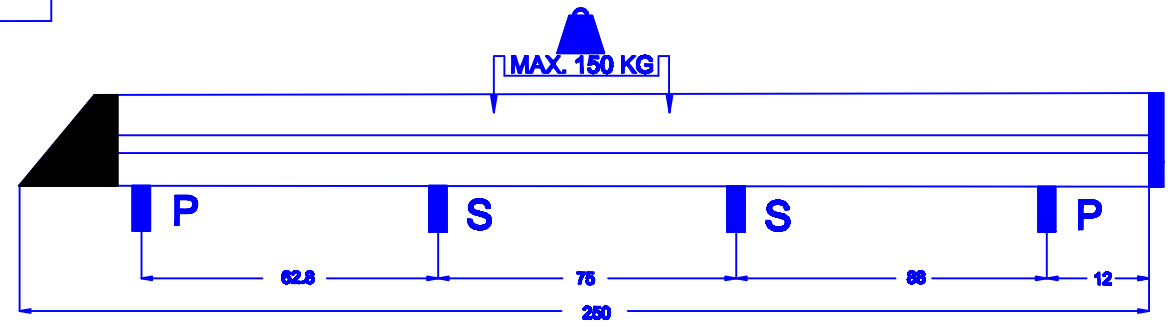

www.kingping.nl
 info@kingping.nl









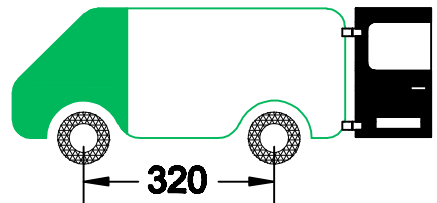

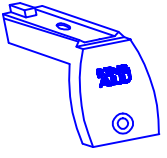
MONTAGEFILM KING-ALU IMPERIAAL

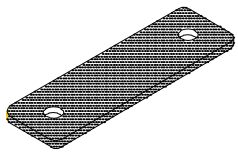
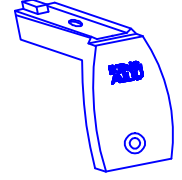
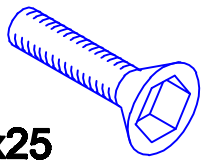
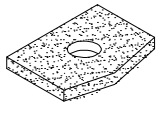
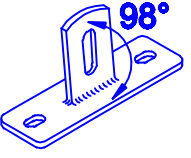
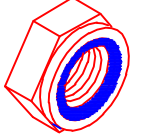
Mercedes Vito

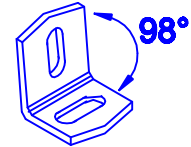
300x143 cm. L2 H1



| | | | | | | | |
|---|--|-----|---|--------|-----|--|-----|
| S |  | 4x |  | 3xD M8 | 16x |  | 6x |
| P |  | 4x |  | M8x25 | 8x |  | 2x |
| |  | 6x |  | M8 | 16x |  | 14x |
| |  | 2x |  | M6x20 | 14x | | |
| |  | 14x |  | 3xD M6 | 14x | | |

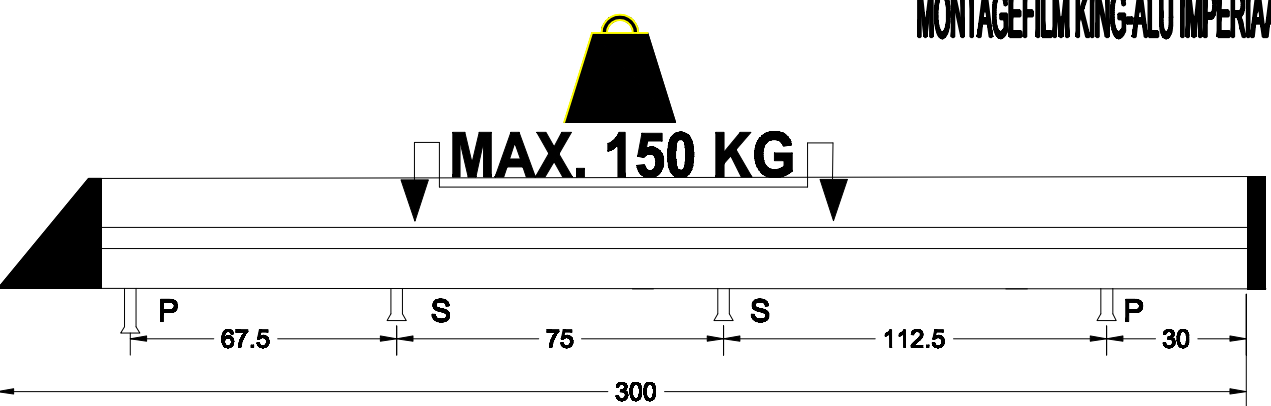

306 ALUMEVD300143X 12/2015

KING PING[®]
www.kingping.nl
info@kingping.nl

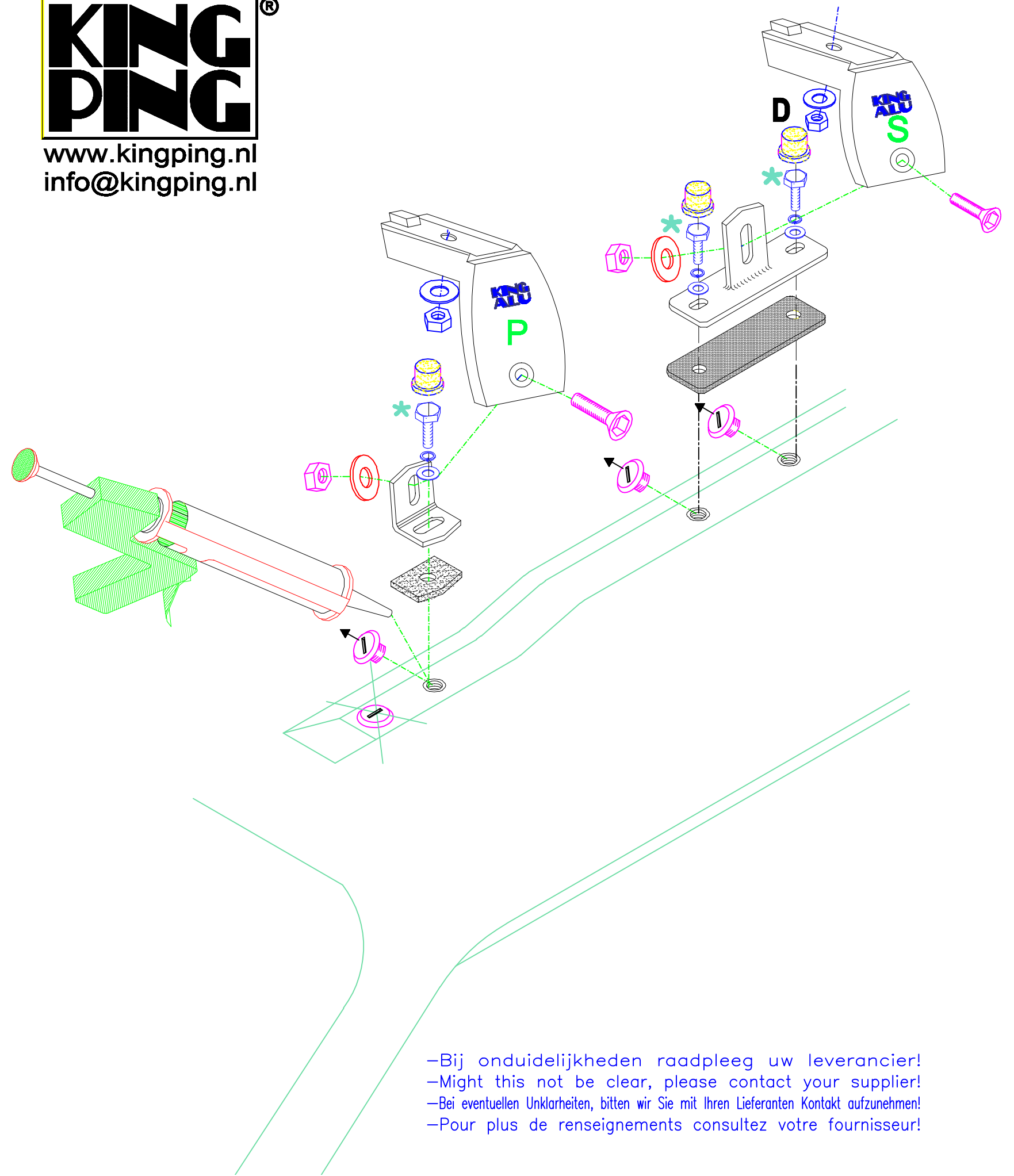







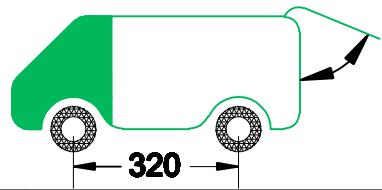

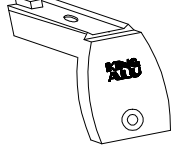
-Bij onduidelijkheden raadpleeg uw leverancier!
 -Might this not be clear, please contact your supplier!
 -Bei eventuellen Unklarheiten, bitten wir Sie mit Ihren Lieferanten Kontakt aufzunehmen!
 -Pour plus de renseignements consultez votre fournisseur!

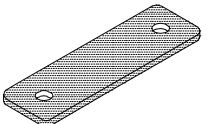
Mercedes Vito

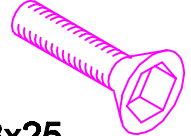
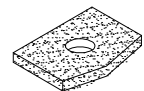
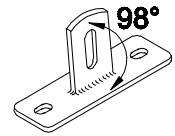
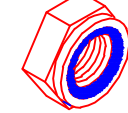
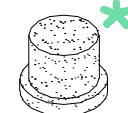
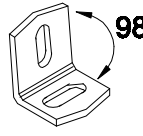
280x143 cm. L2 H1



| | | | |
|---|---|---|---|
| S |  4x |  16x |  6x |
| P |  4x |  8x |  2x |
| |  6x |  16x |  14x |
| |  2x |  14x | |
| |  14x |  14x | |

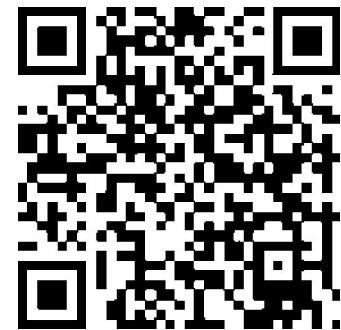

MONTAGEFILM KING-ALU IMPERIAAL

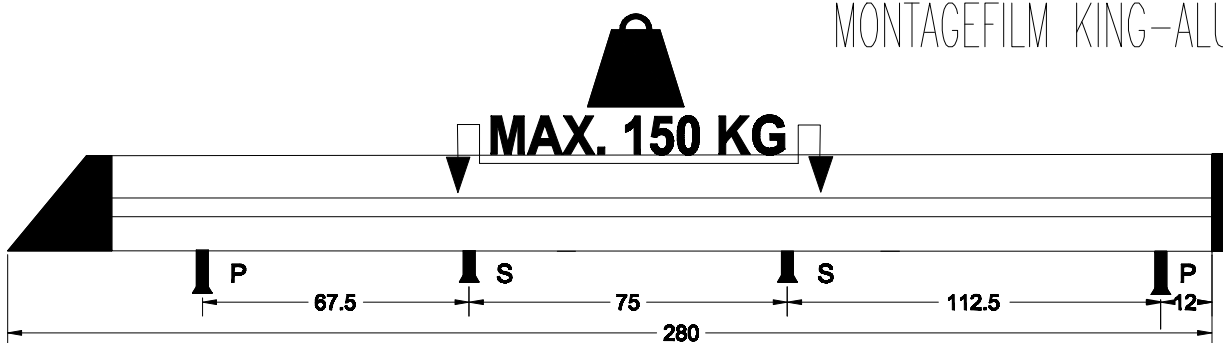

www.kingping.nl
info@kingping.nl

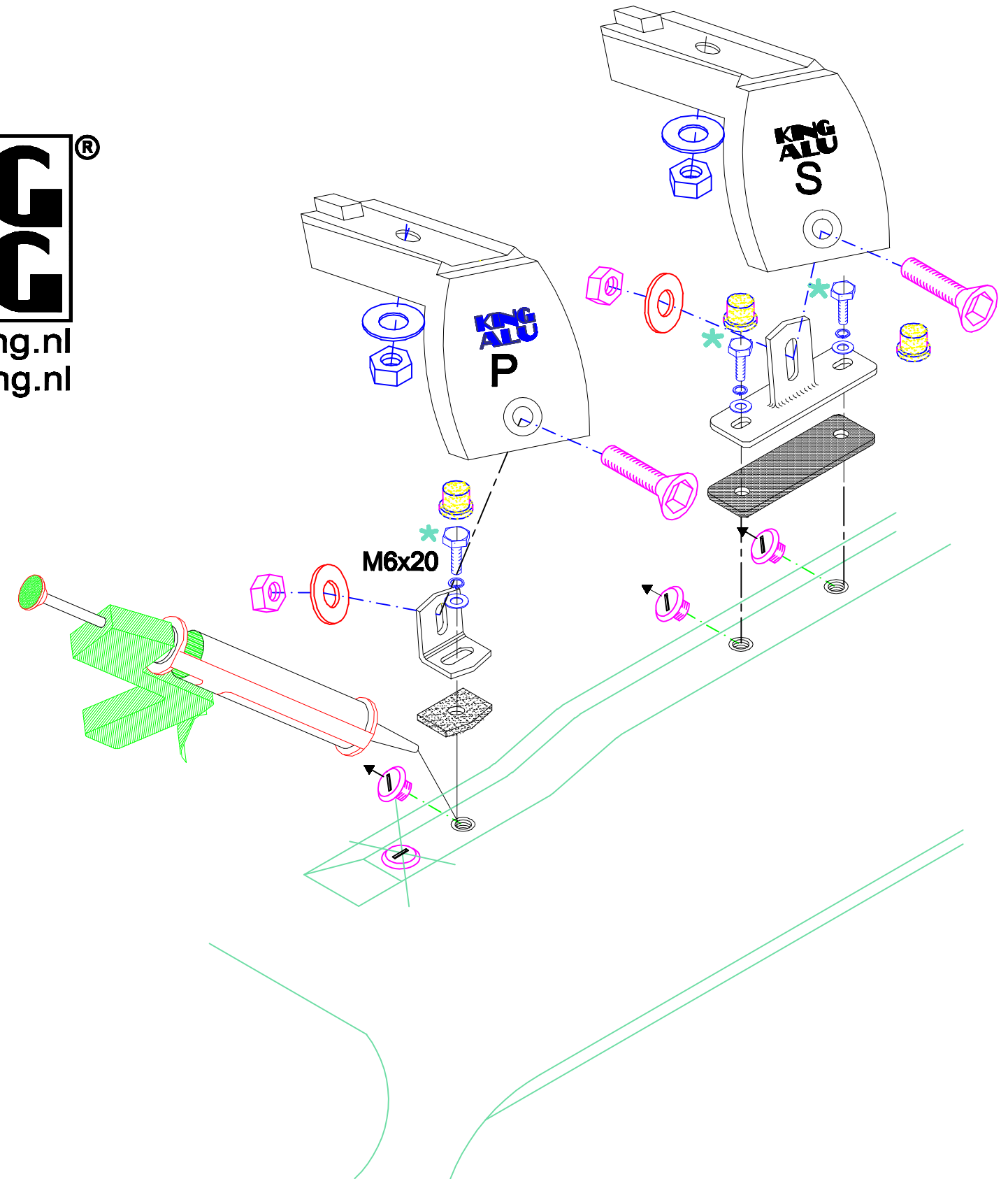

–Bij onduidelijkheden raadpleeg uw leverancier!
 –Might this not be clear, please contact your supplier!
 –Bei eventuellen Unklarheiten, bitten wir Sie mit Ihren Lieferanten Kontakt aufzunehmen!
 –Pour plus de renseignements consultez votre fournisseur!

Mercedes Vito

320x143 cm. L3 H1

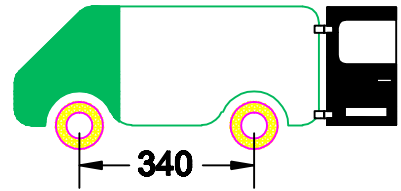

| | | |
|-----|-----|---|
| 4x | 16x | 6x |
| 6x | 2x | |
| 4x | 2x | 14x |
| 14x | 14x | <p>www.kingping.nl info@kingping.nl</p> |
| 8x | 14x | |
| 16x | 14x | |

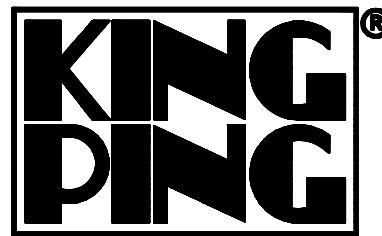

www.kingping.nl
info@kingping.nl

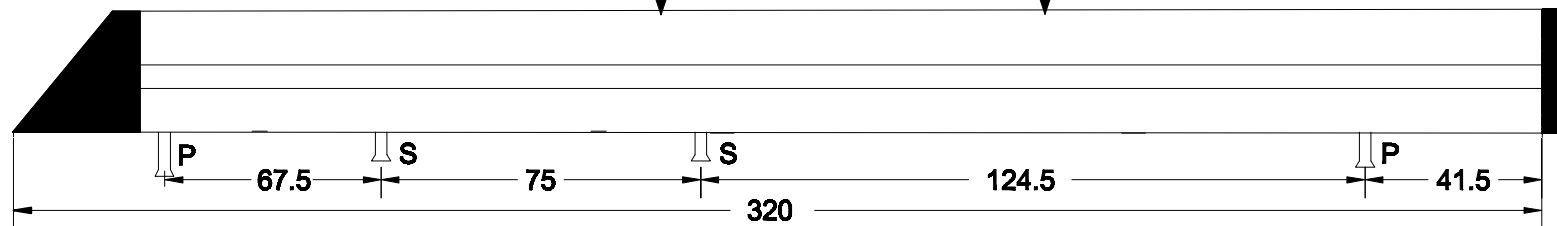
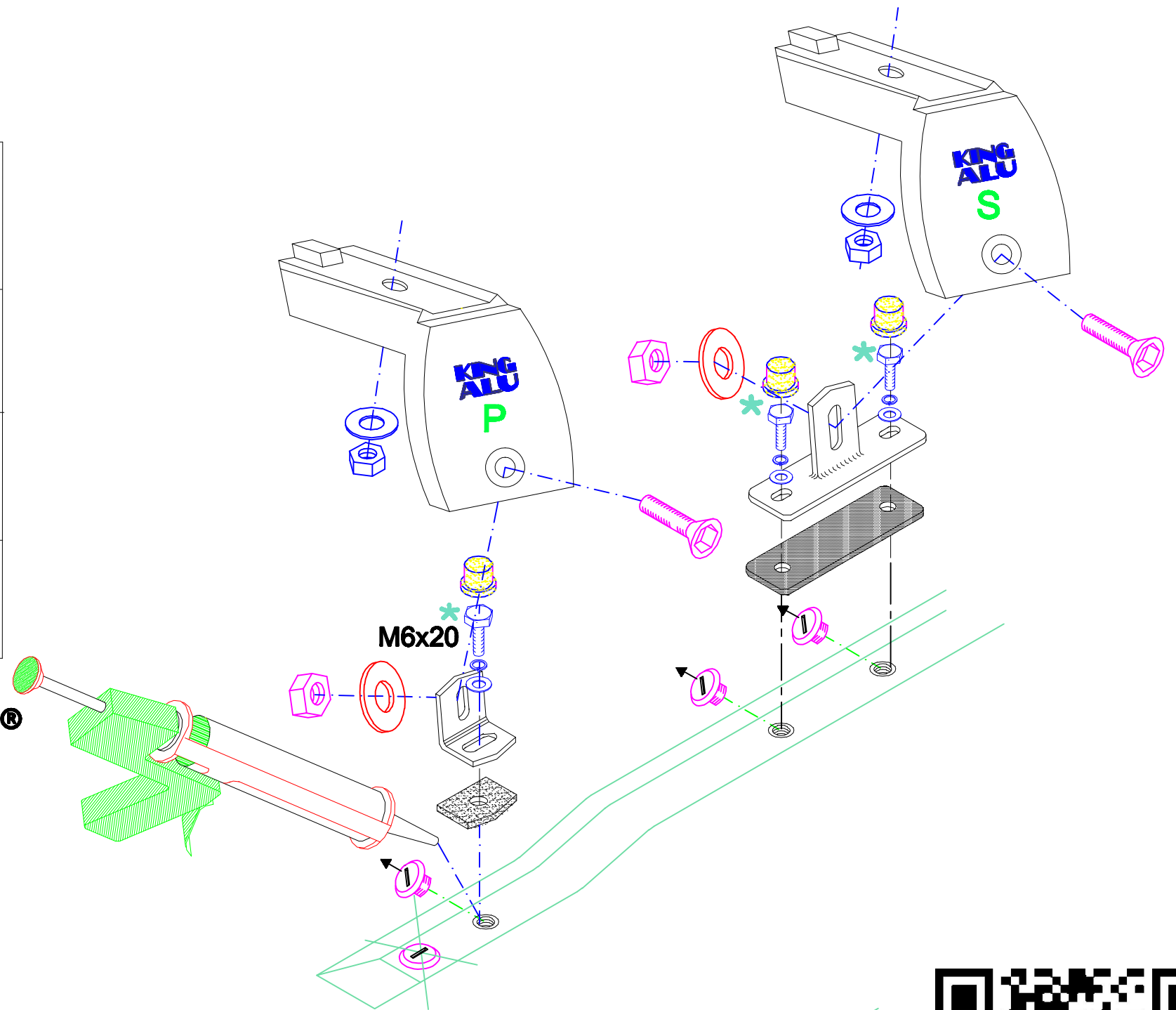

MONTAGEFILM KING-ALU IMPERIAAL

- Bij onduidelijkheden raadpleeg uw leverancier!
- Might this not be clear, please contact your supplier!
- Bei eventuellen Unklarheiten, bitten wir Sie mit Ihren Lieferanten Kontakt aufzunehmen!
- Pour plus de renseignements consultez votre fournisseur!

Mercedes Vito

310x143 cm. L3 H1

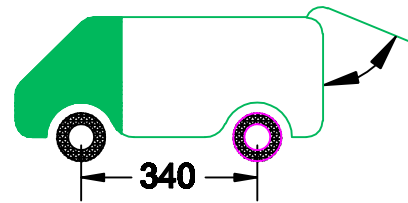

| | | | | |
|----|-----|--------|-----|-----|
| S | 4x | 3xD M8 | 16x | 6x |
| | 4x | 98° | 2x | 2x |
| P | 4x | M8x25 | 8x | 6x |
| | 4x | M6x20 | 14x | 14x |
| M6 | 14x | M6 | 14x | |
| M8 | 16x | 3xD M6 | 14x | |

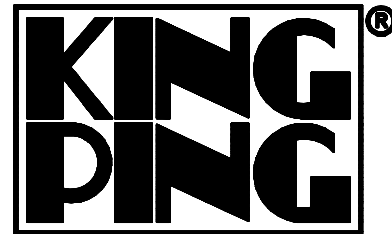

www.kingping.nl
info@kingping.nl

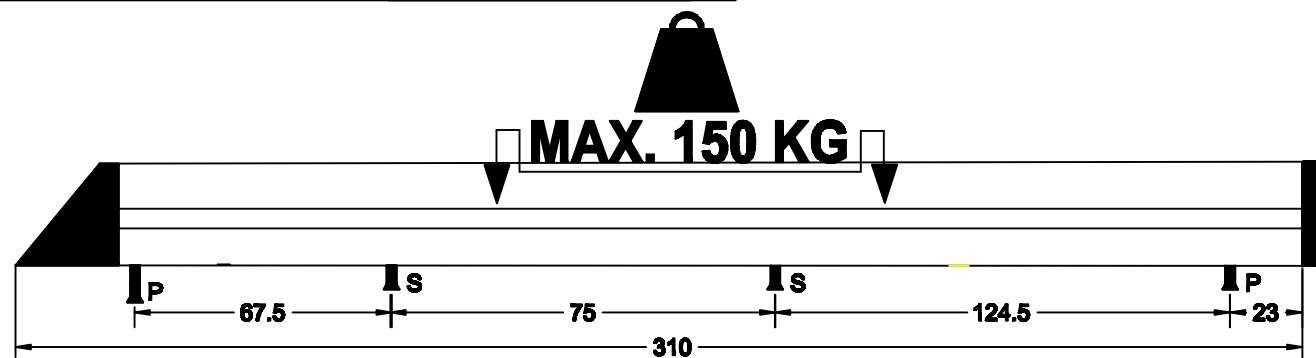
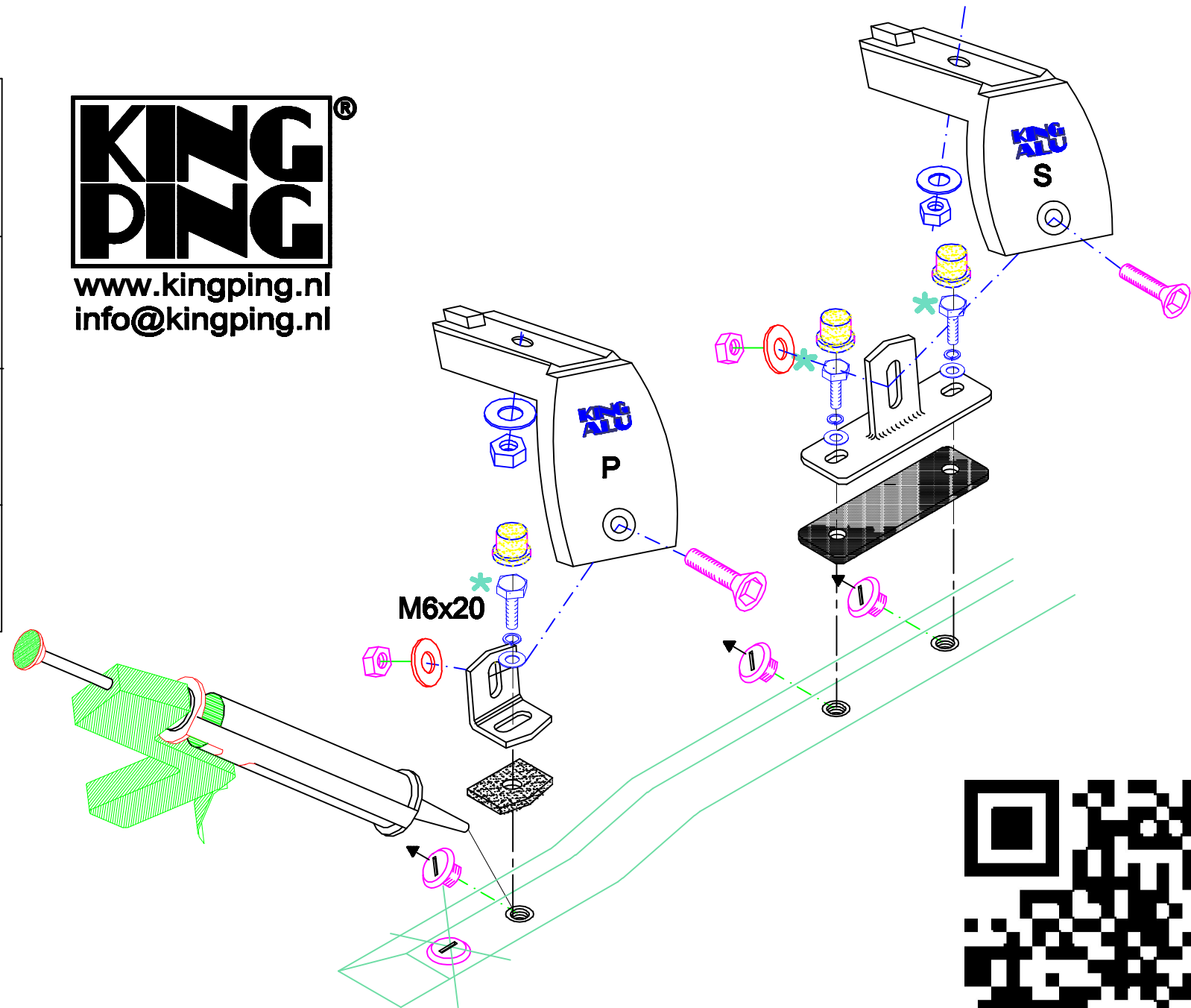

MONTAGEFILM KING-ALU IMPERIAAL

- Bij onduidelijkheden raadpleeg uw leverancier!
- Might this not be clear, please contact your supplier!
- Bei eventuellen Unklarheiten, bitten wir Sie mit Ihren Lieferanten Kontakt aufzunehmen!
- Pour plus de renseignements consultez votre fournisseur!