









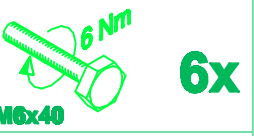

Citroën Jumper 2007
Fiat Ducato 2007
Peugeot Boxer 2007

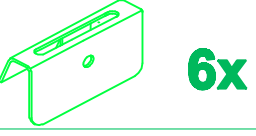

300x173 cm. L1 H1

	6x		6x		6x
	6x		12x		6x
	6x		18x		6x
	6x		6x		

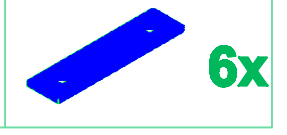
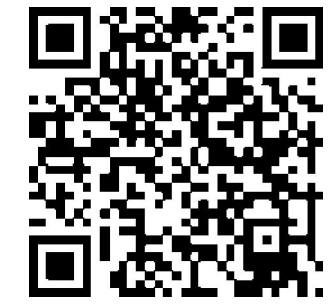



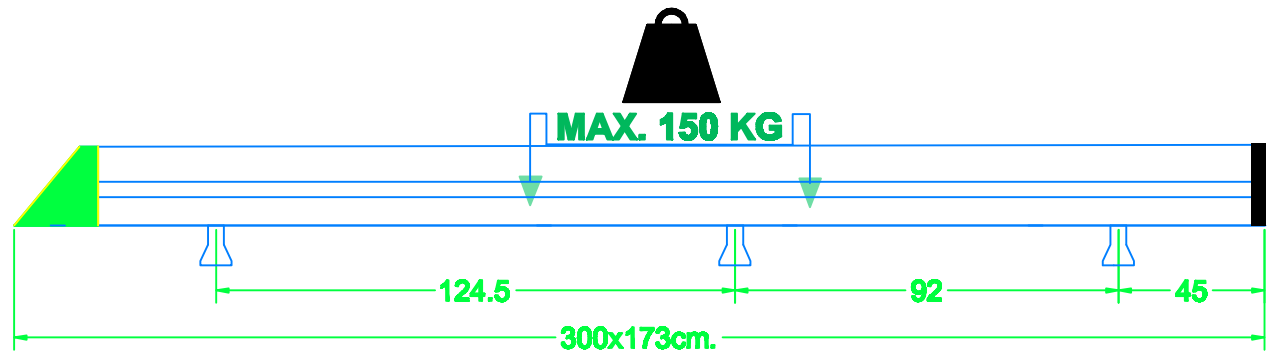
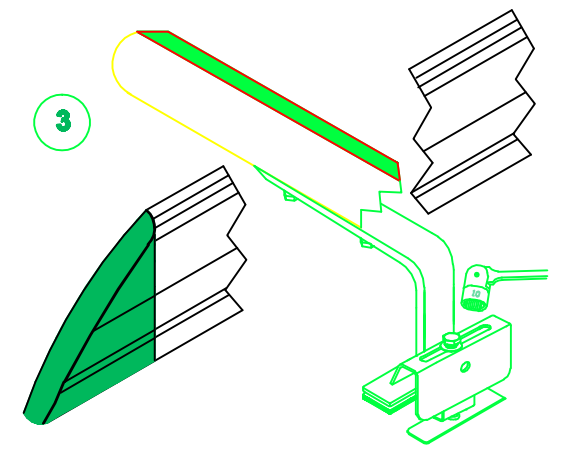
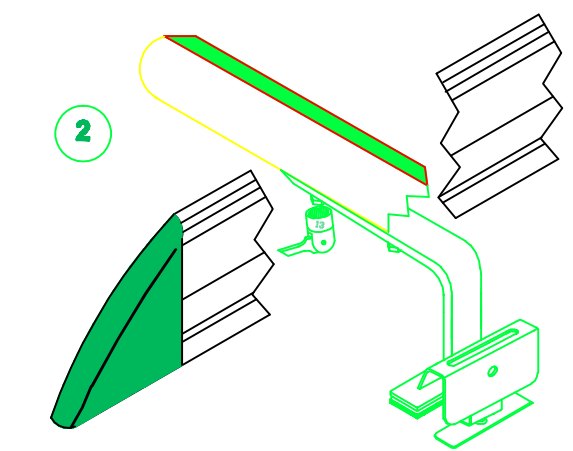
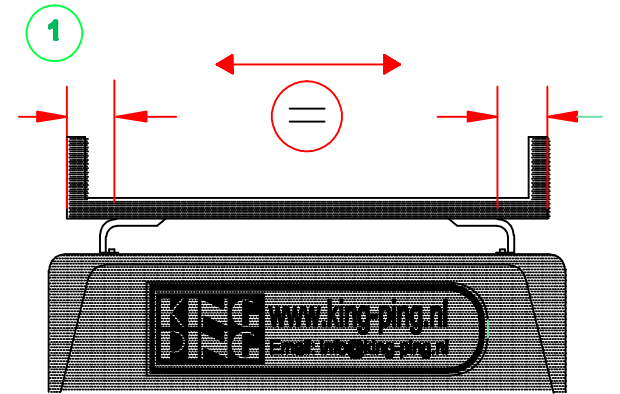
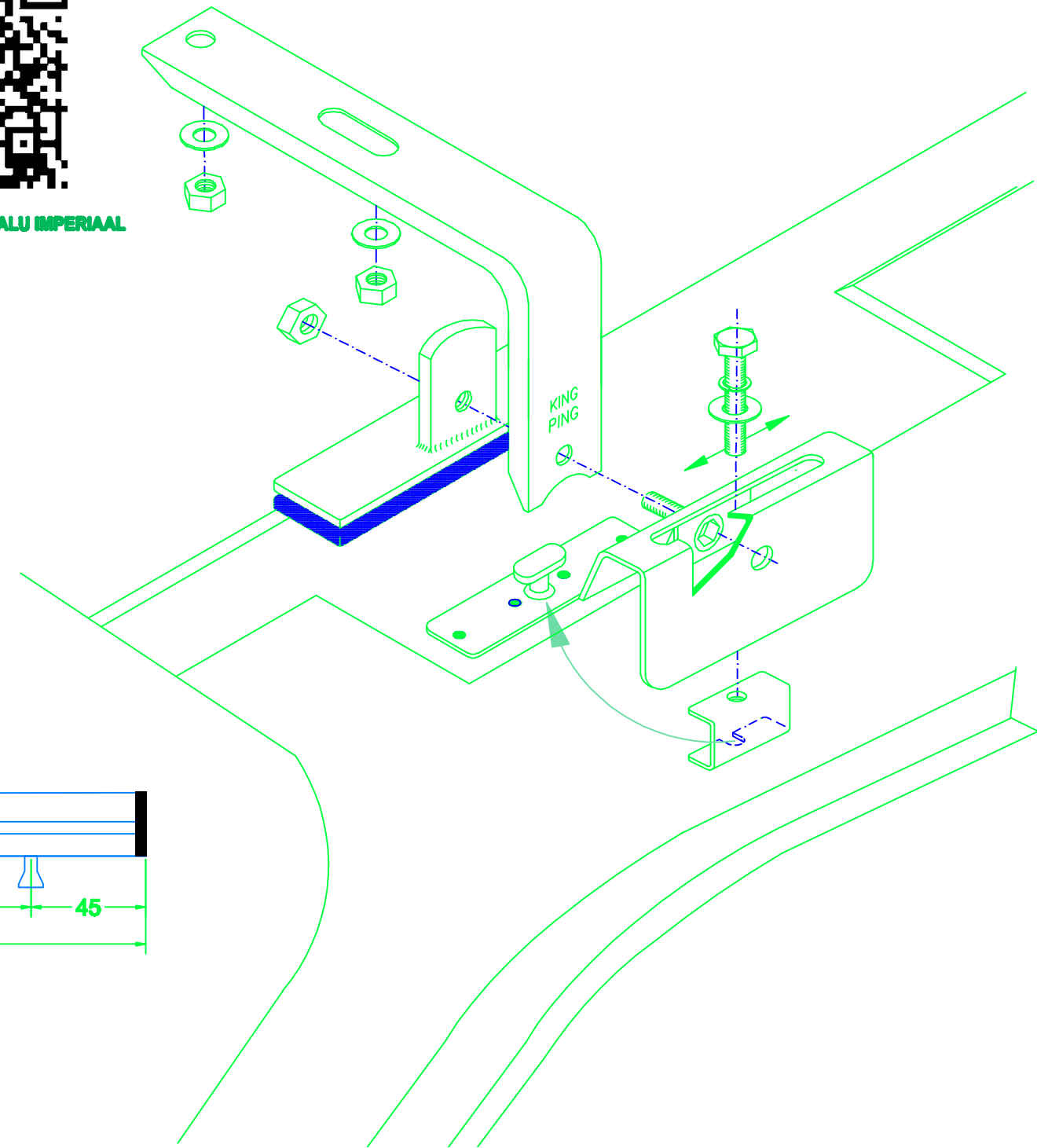







MONTAGEFILM KING-ALU IMPERIAAL

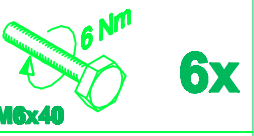

Citroën Jumper 2007
Fiat Ducato 2007
Peugeot Boxer 2007

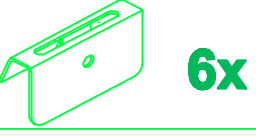

280x173 cm. L1 H2

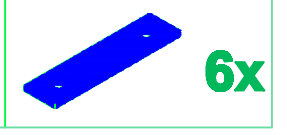
	6x		6x		6x
	6x		12x		6x
	6x		18x		6x
	6x		6x		

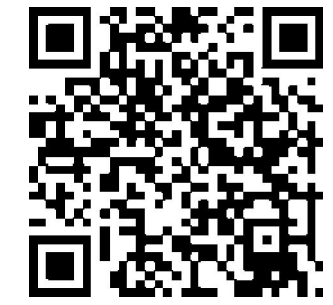



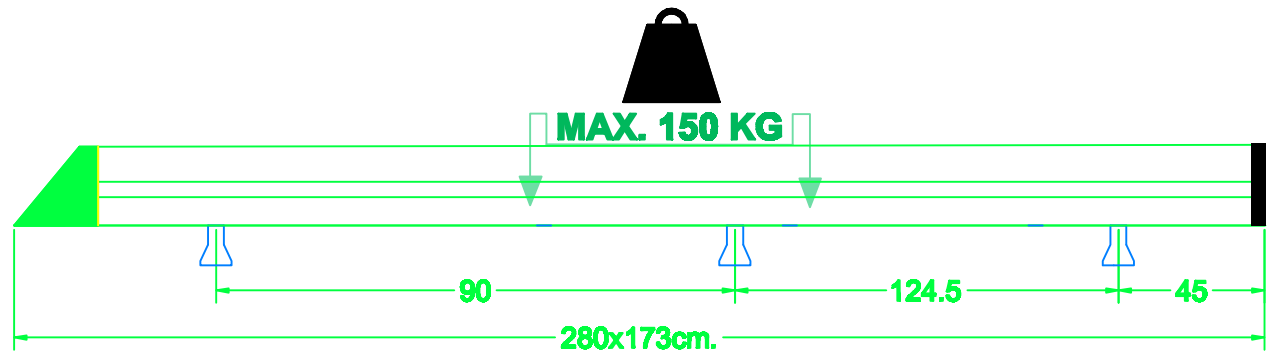
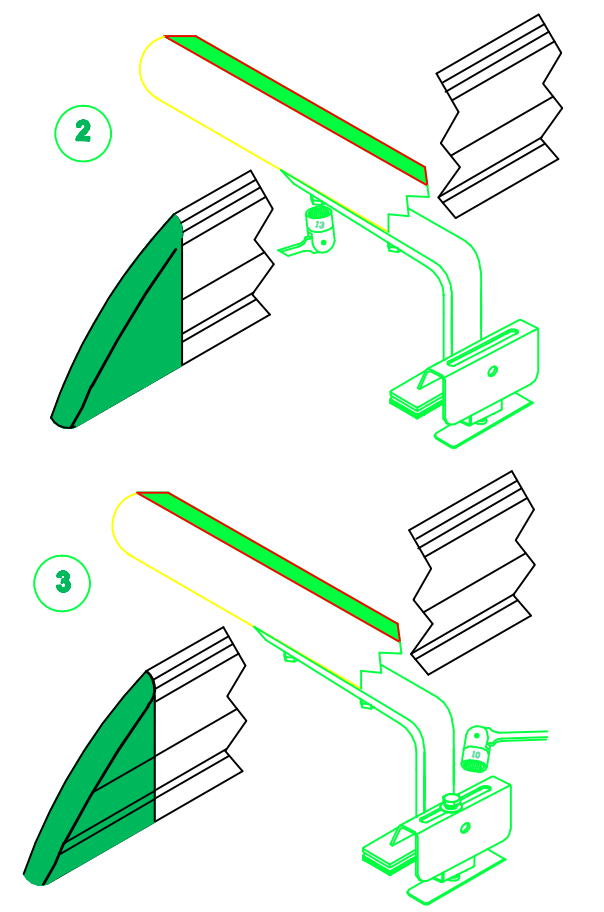
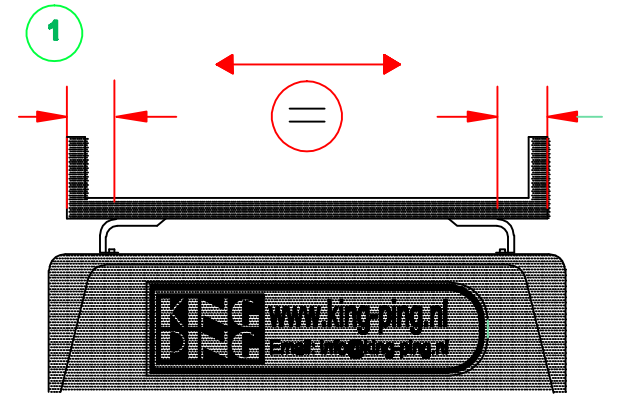
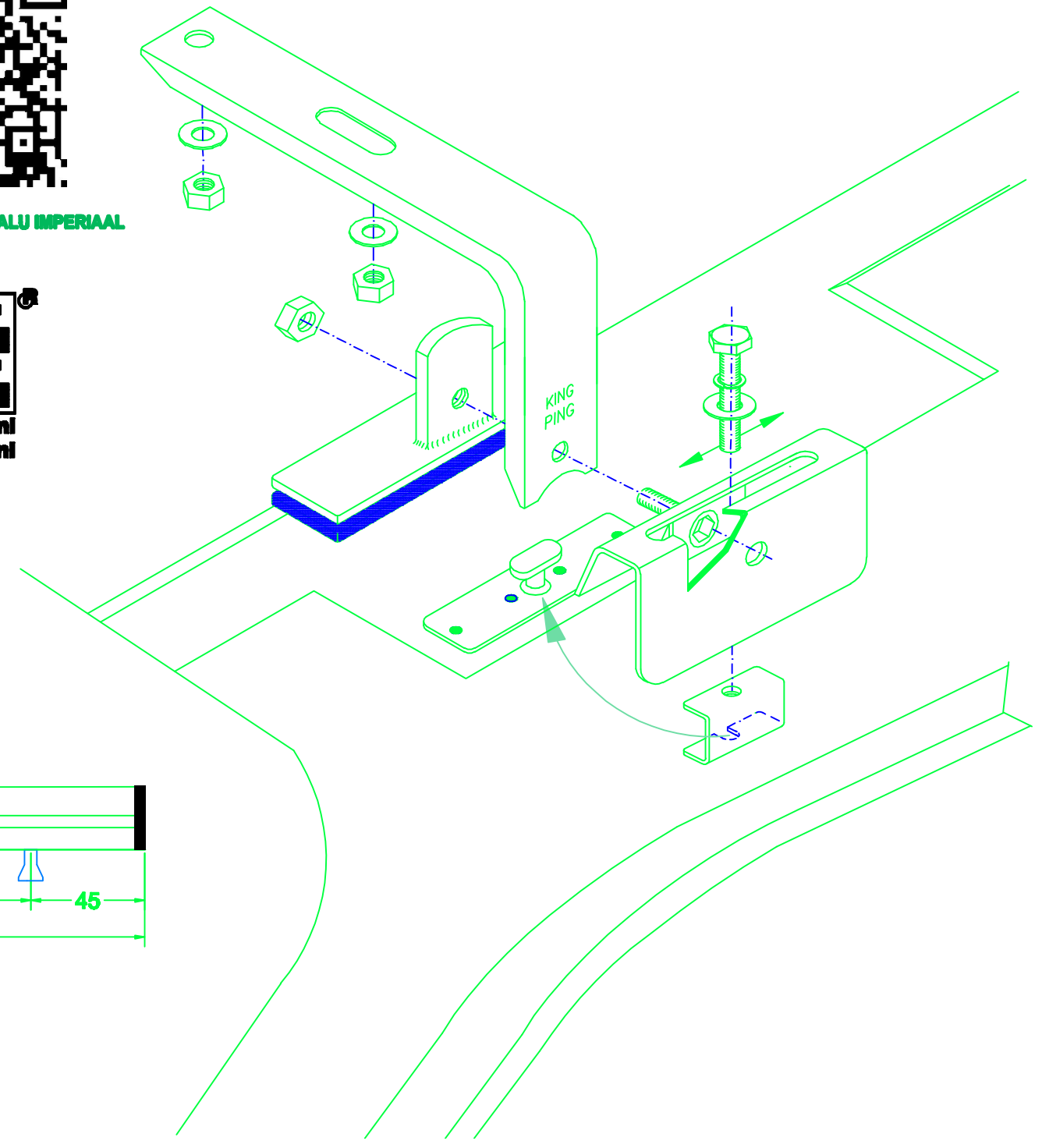

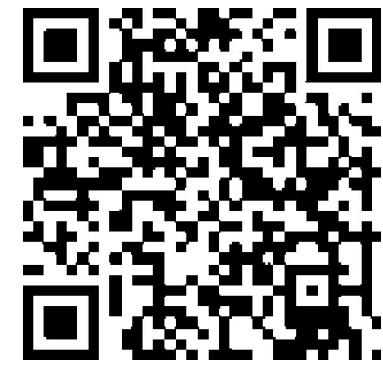
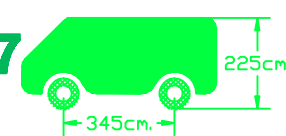

MONTAGEFILM KING-ALU IMPERIAAL

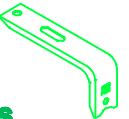

Citroën Jumper 2007
Fiat Ducato 2007
Peugeot Boxer 2007
350x173cm. L2 H1

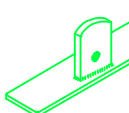

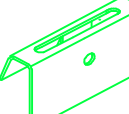
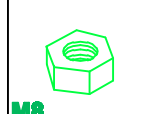
MONTAGEFILM KING-ALU IMPERIAAL

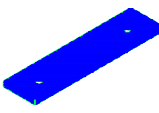
	6x	 14 Nm	6x	 6 Nm	6x
	6x		12x		6x
	6x		18x		6x
	6x				6x

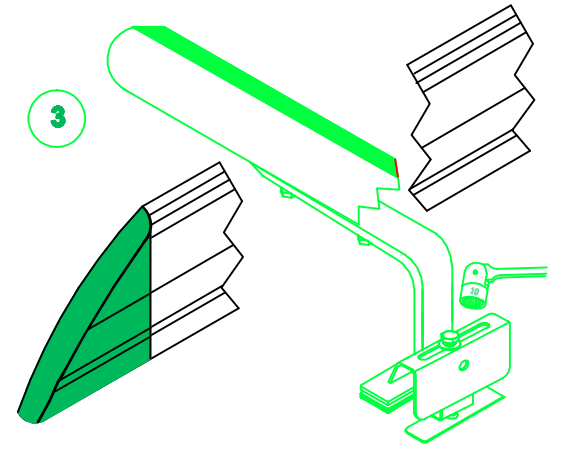
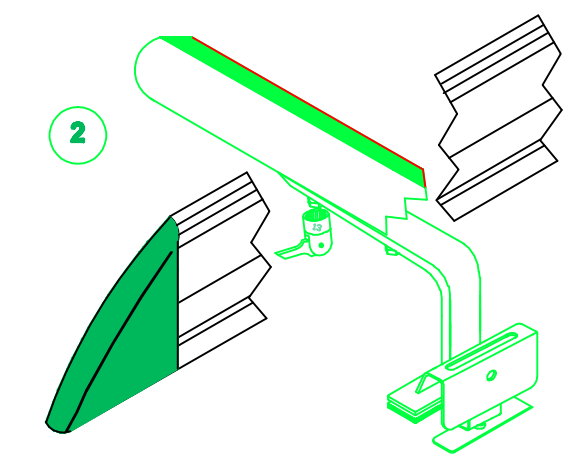
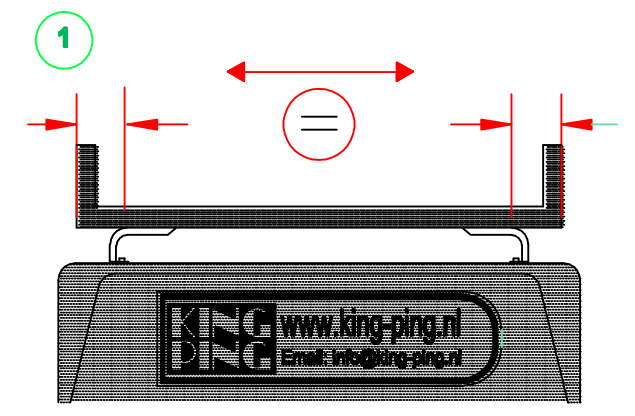
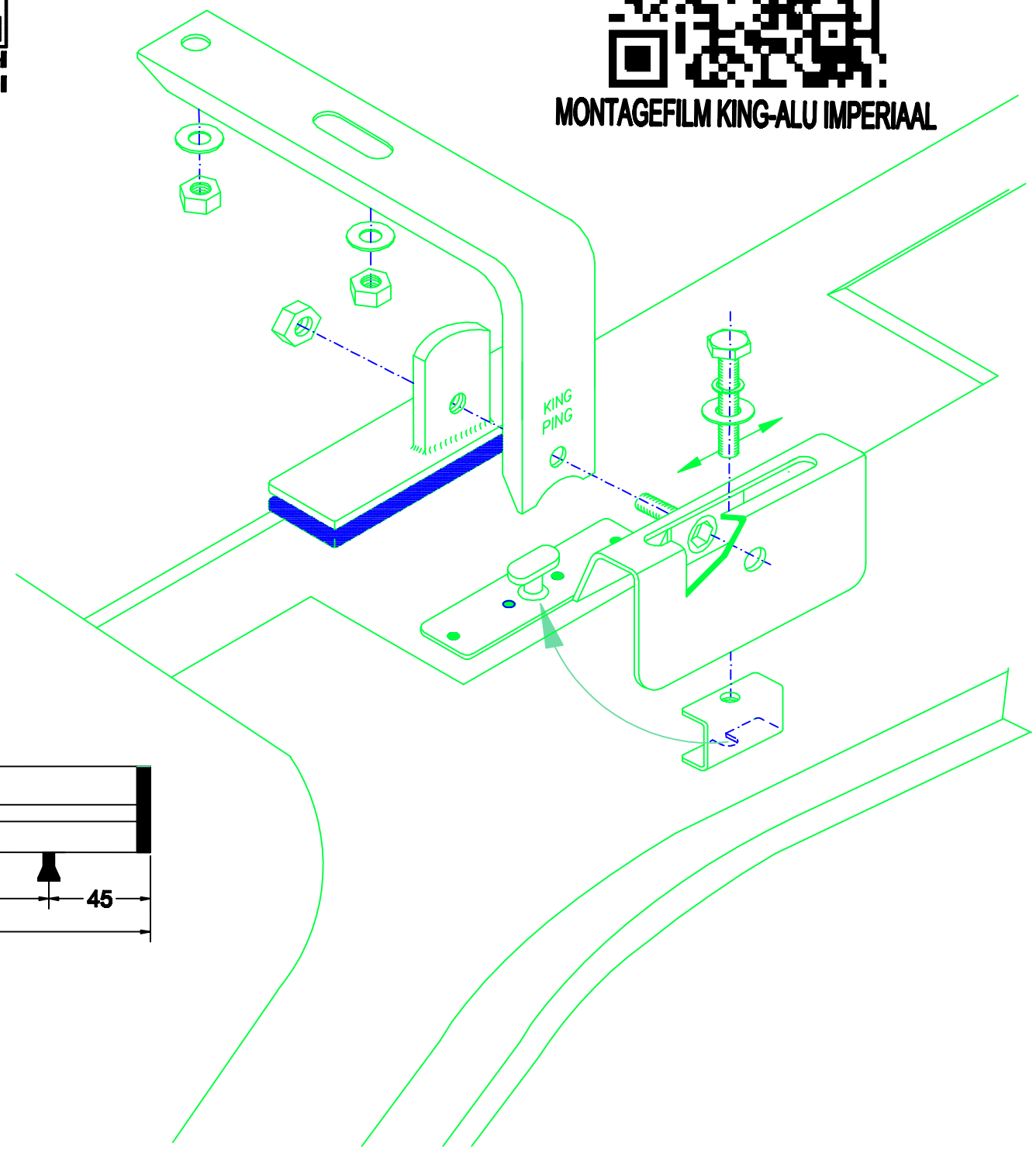
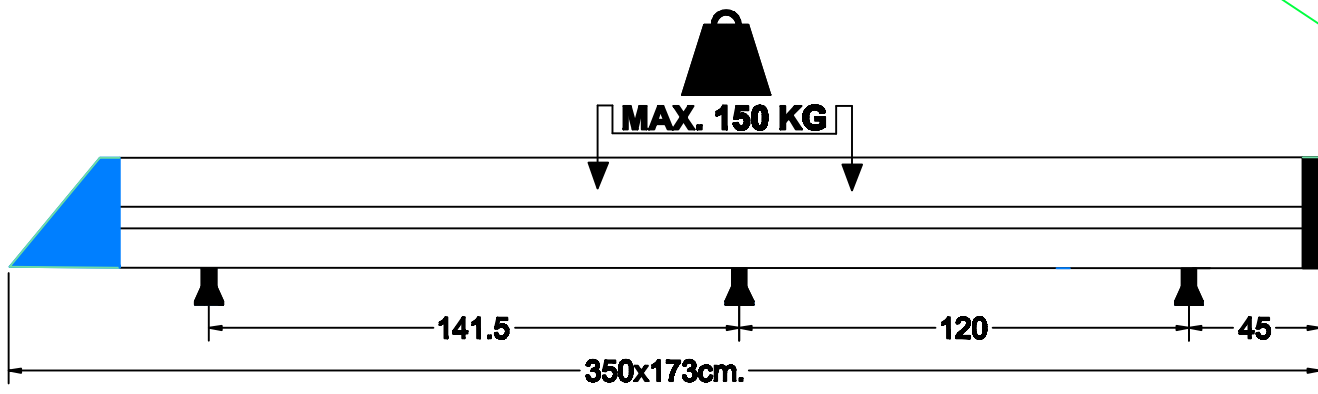

12/2015 ALUCJML350173S ALUFDML350173S ALUPBML350173S



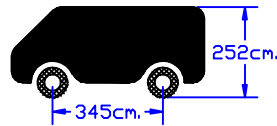



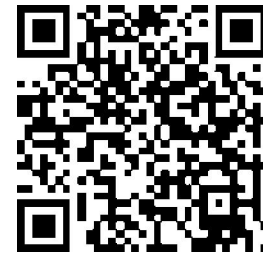

**Citroën Jumper MODEL 2006-
Fiat Ducato MODEL 2006-
Peugeot Boxer MODEL 2006-
320x173 cm. L2 H2**

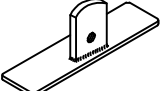

KING PING
www.kingping.nl
info@kingping.nl

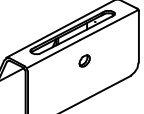

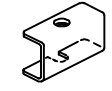
MONTAGEFILM KING-ALU IMPERIAL

	6x		6x		6x
	6x		12x		6x
	6x		18x		6x
	6x				6x



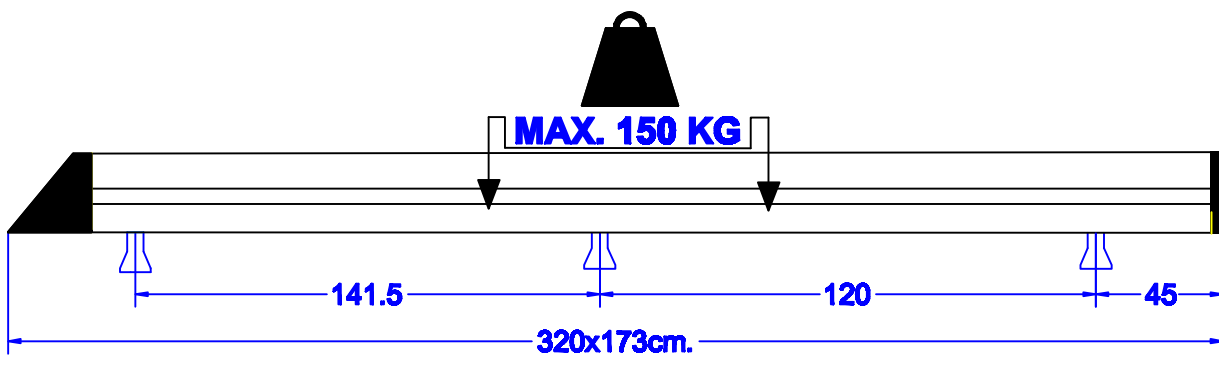
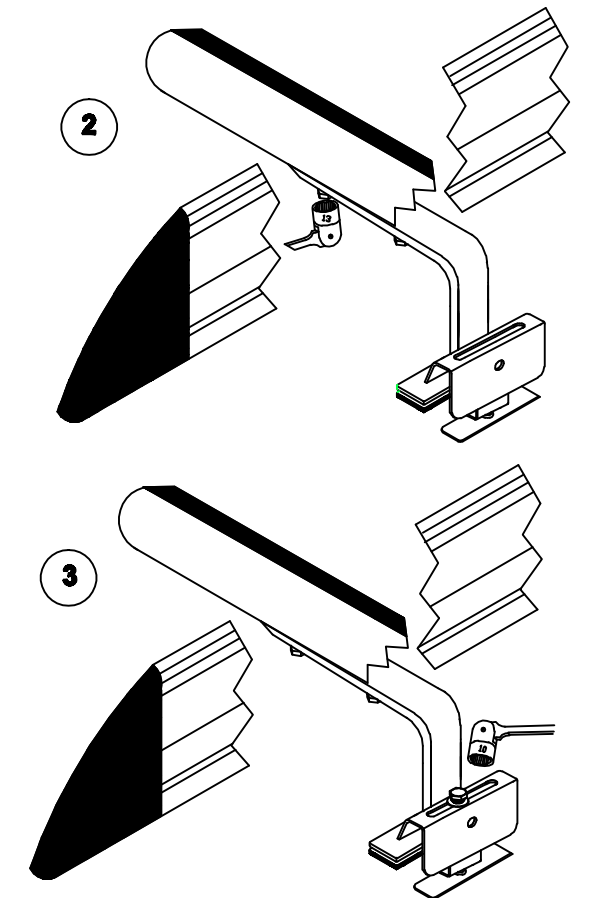
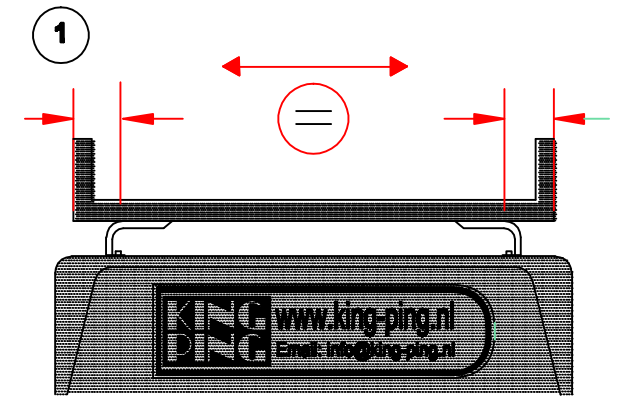
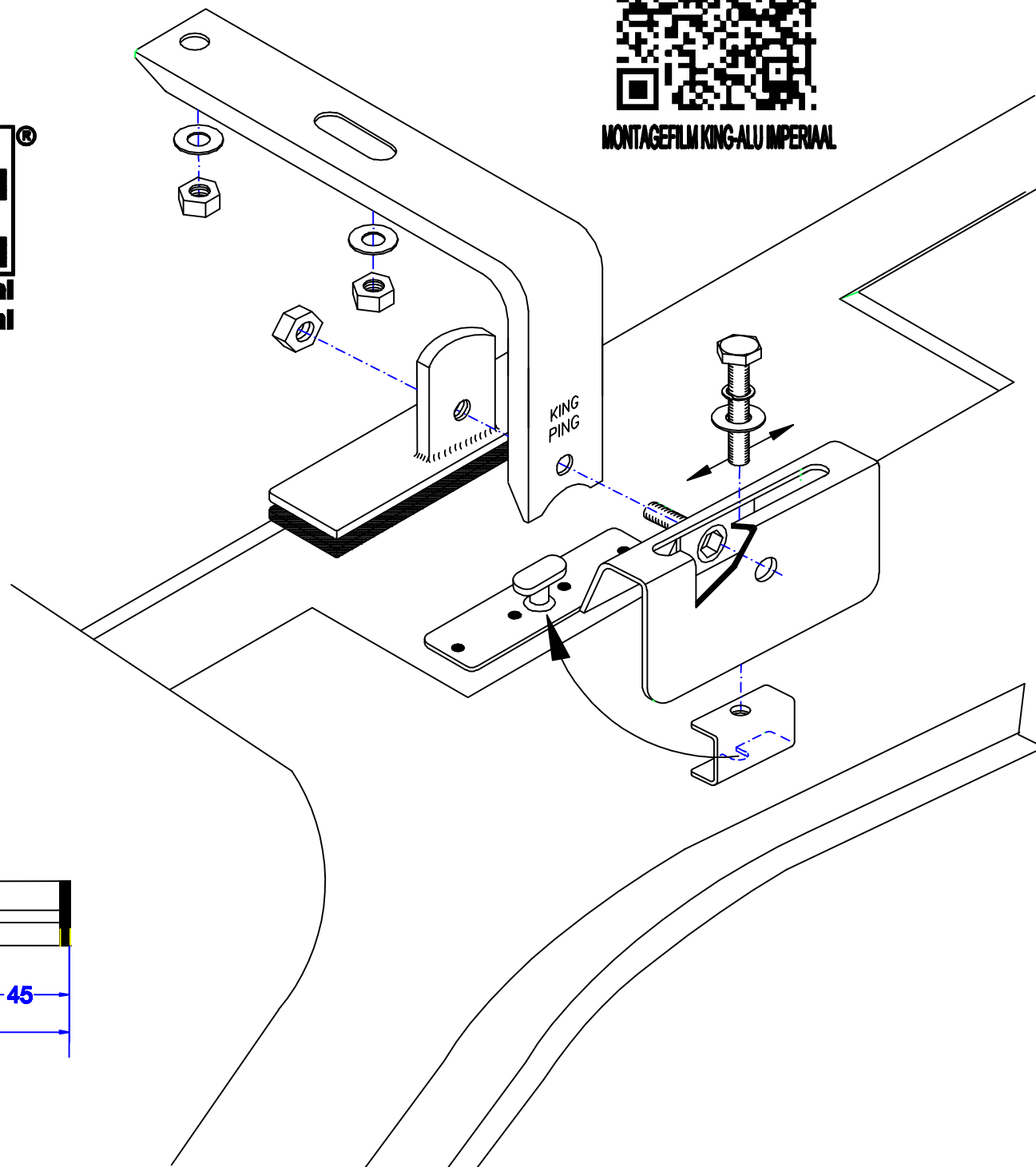



KING ALU www.kingping.nl
Email: info@kingping.nl

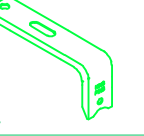
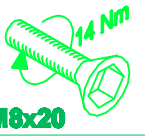

12/2015 ALUCJMH320173S ALUFDMH320173S ALUPBMH320173S

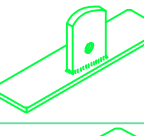
Citroën Jumper 2007
Fiat Ducato 2007
Peugeot Boxer 2007
380x173 cm. L3 H2

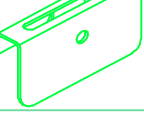
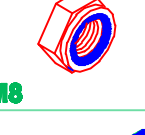

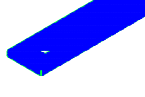
	8x	 14 Nm M8x20	8x	 6 Nm M6x40	8x
	8x	 3xD M8	16x	 M6	8x
	8x	 M8	24x	 3xD M6	8x
	8x		8x		

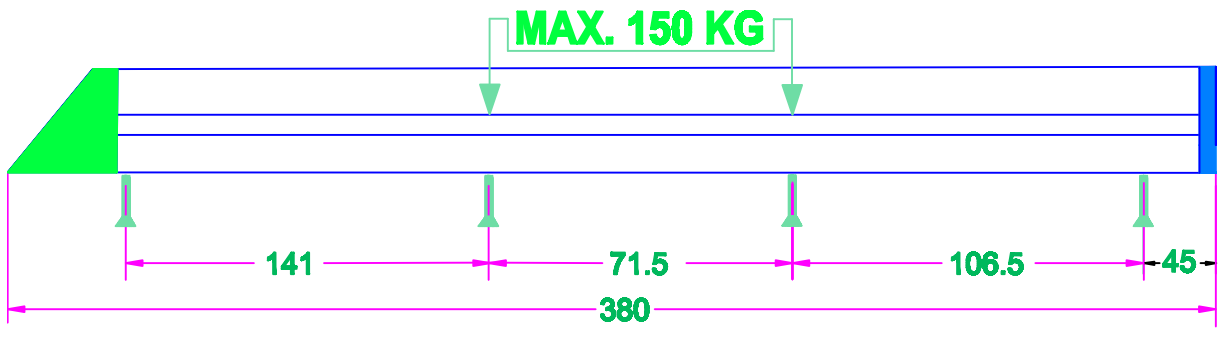



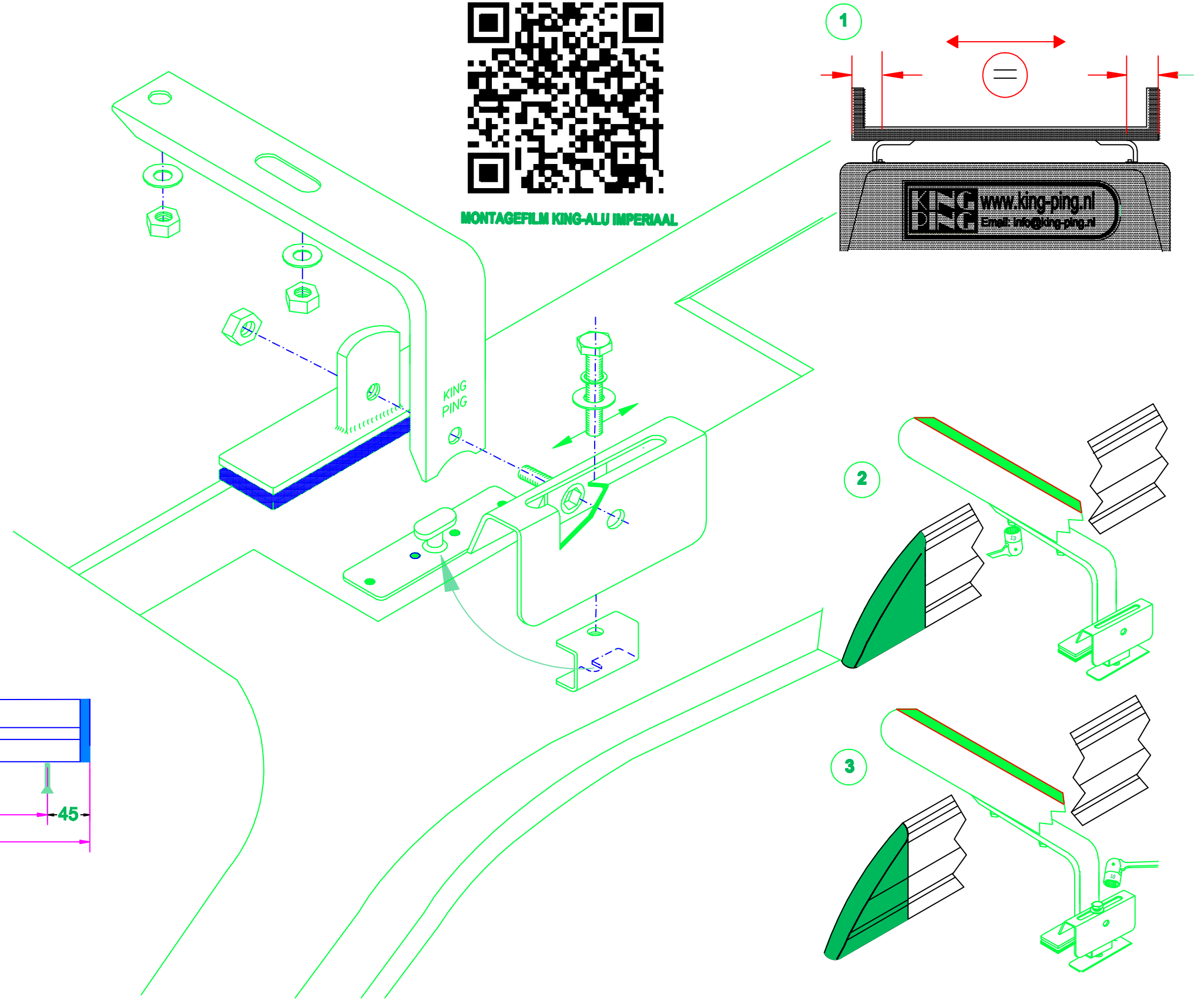



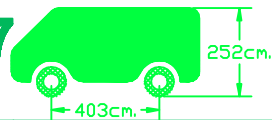

MONTAGEFILM KING-ALU IMPERIAAL

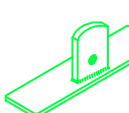

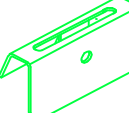
Citroën Jumper 2007
Fiat Ducato 2007
Peugeot Boxer 2007
 400x173 cm. L4 H2

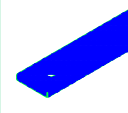

 10x	 10x	 10x
 10x	 20x	 10x
 10x	 30x	 10x
 10x	 10x	



MONTAGEFILM KING-ALU IMPERIAAL

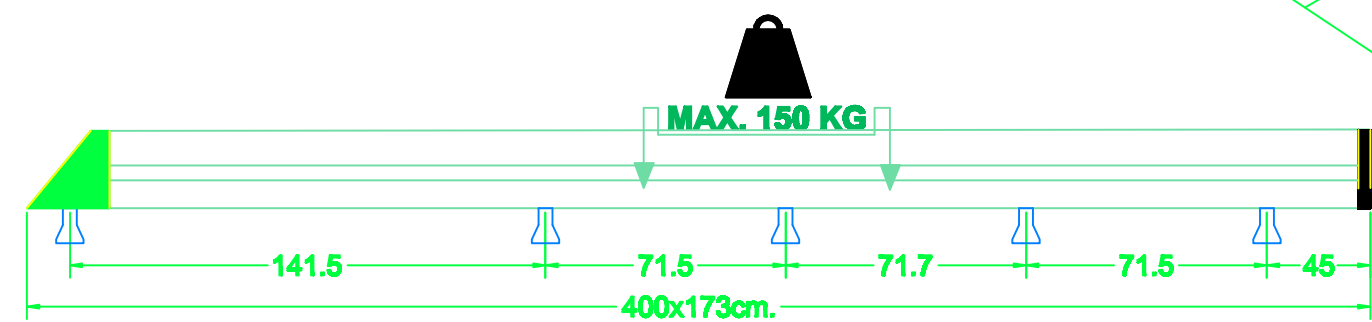
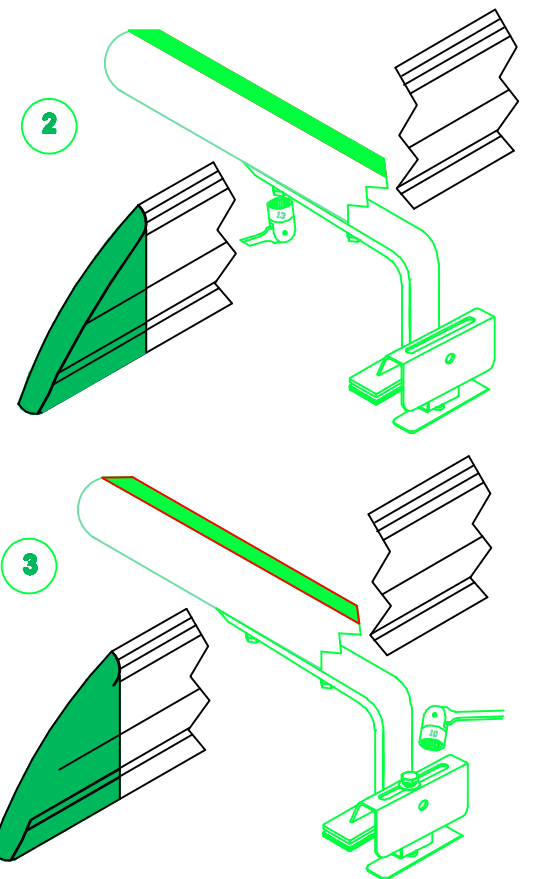
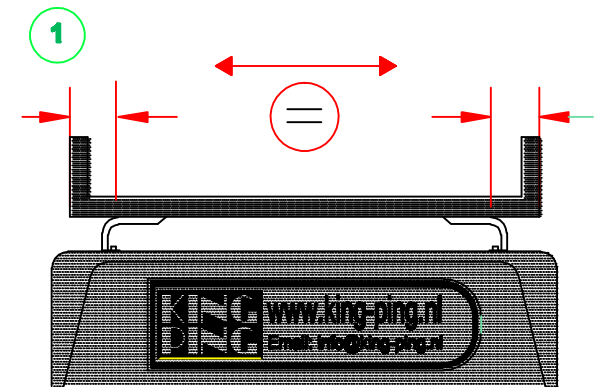
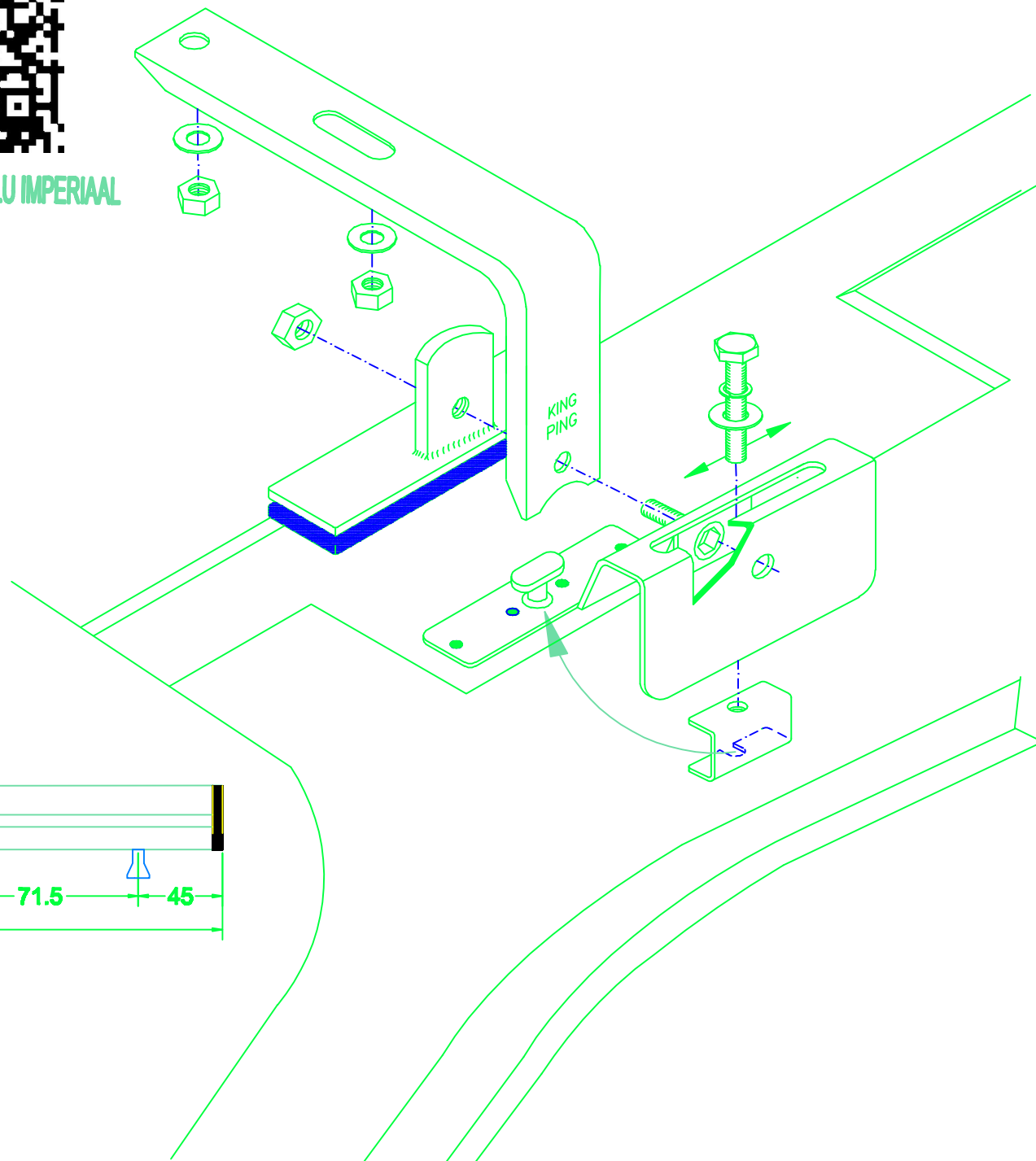

12/2015 ALUCJEH400173S ALUFDEH400173S ALUPBEH400173S