

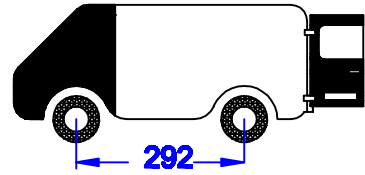

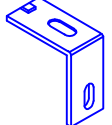

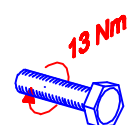



Citroën Jumpy TYPE XS 2016
Peugeot Expert COMPACT 2016
Toyota ProAce COMPACT 2016

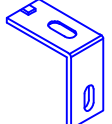

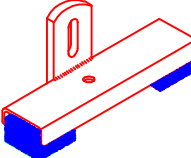
250x141cm.



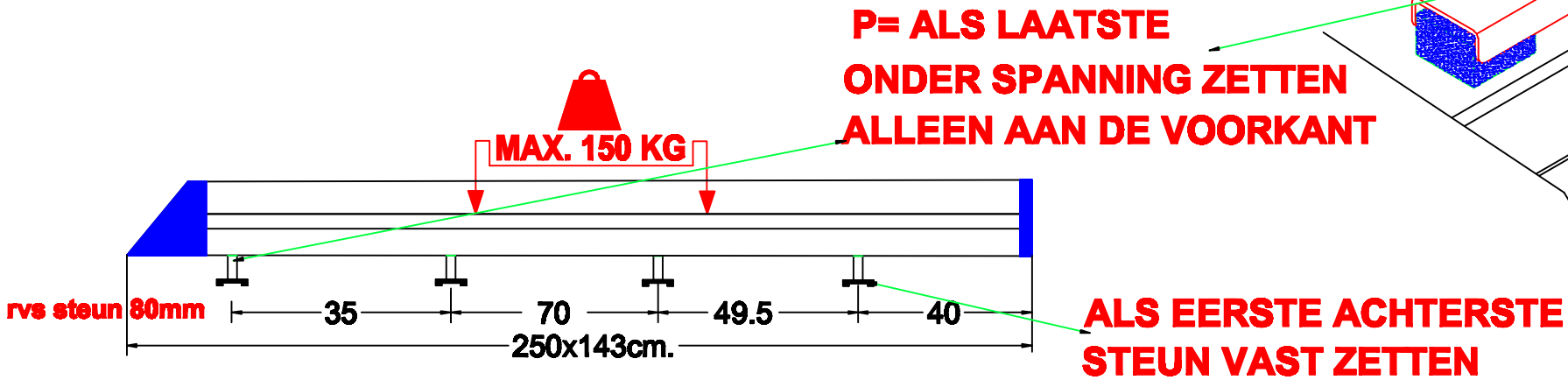
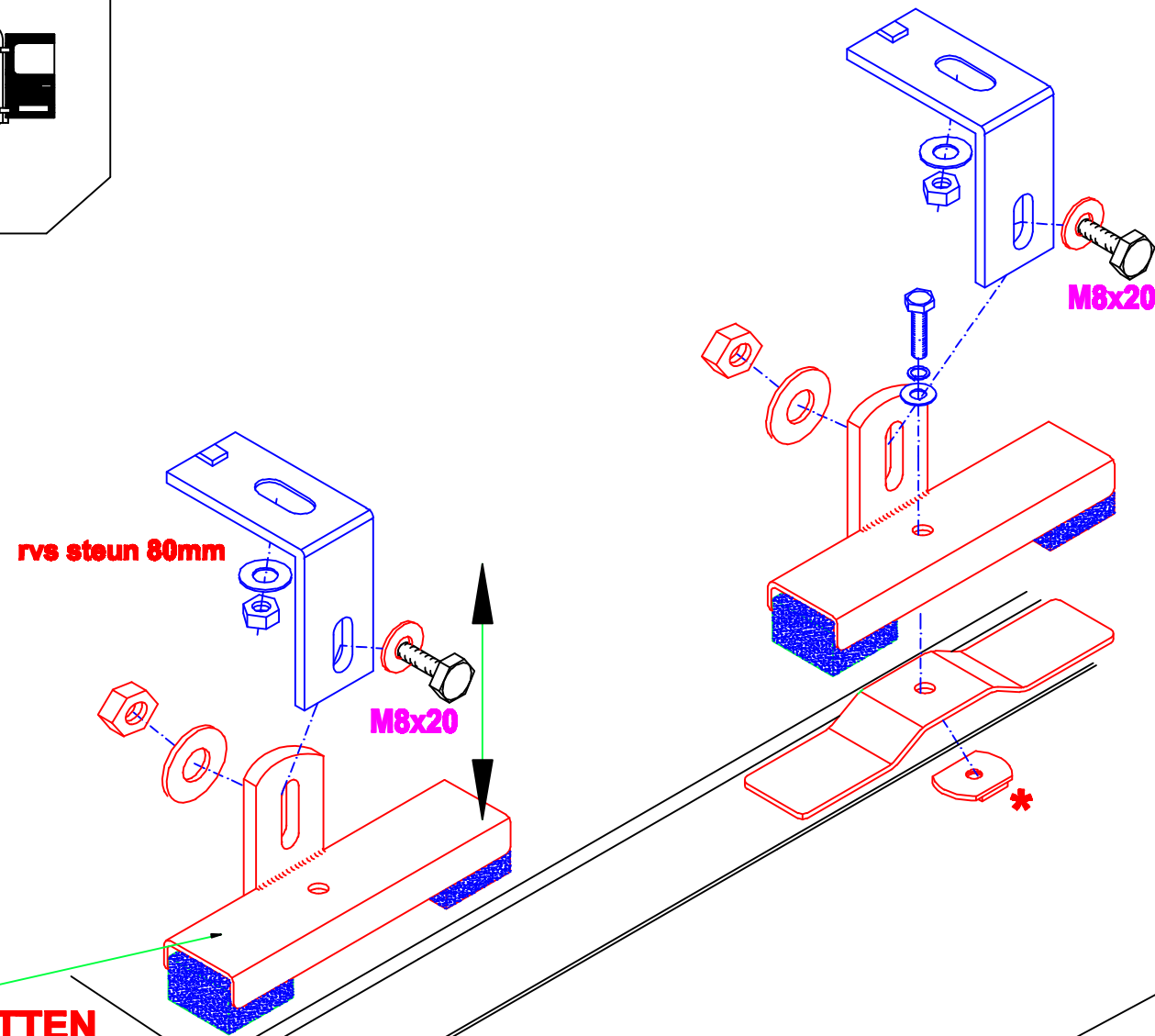

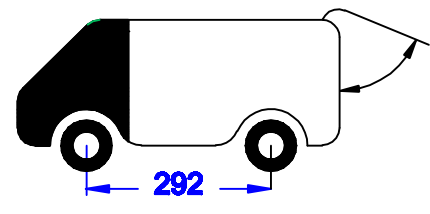

 rvs steun 60mm	6x	 M8x20	8x	 M6x20	6x
 rvs steun 80mm	2x	 M8	16x	 *	6x
 rvs steun 80mm	8x	 3xD M8	16x	 *	6x
			 *	6x	

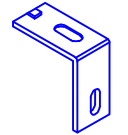
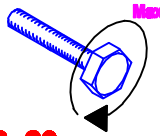
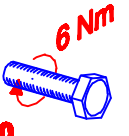
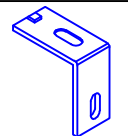
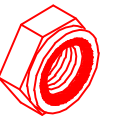

Citroën Jumpy TYPE XS 2016
Peugeot Expert COMPACT 2016
Toyota ProAce COMPACT 2016

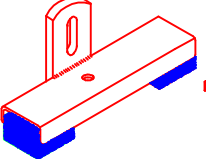

220x141cm.

 8x rvs steun 60mm	 10x M8x20	 6x M6x20
 2x rvs steun 80mm	 20x M8	 * 6x M6
 10x	 20x 3xD M8	 * 6x 2xD M6
		 * 6x M6

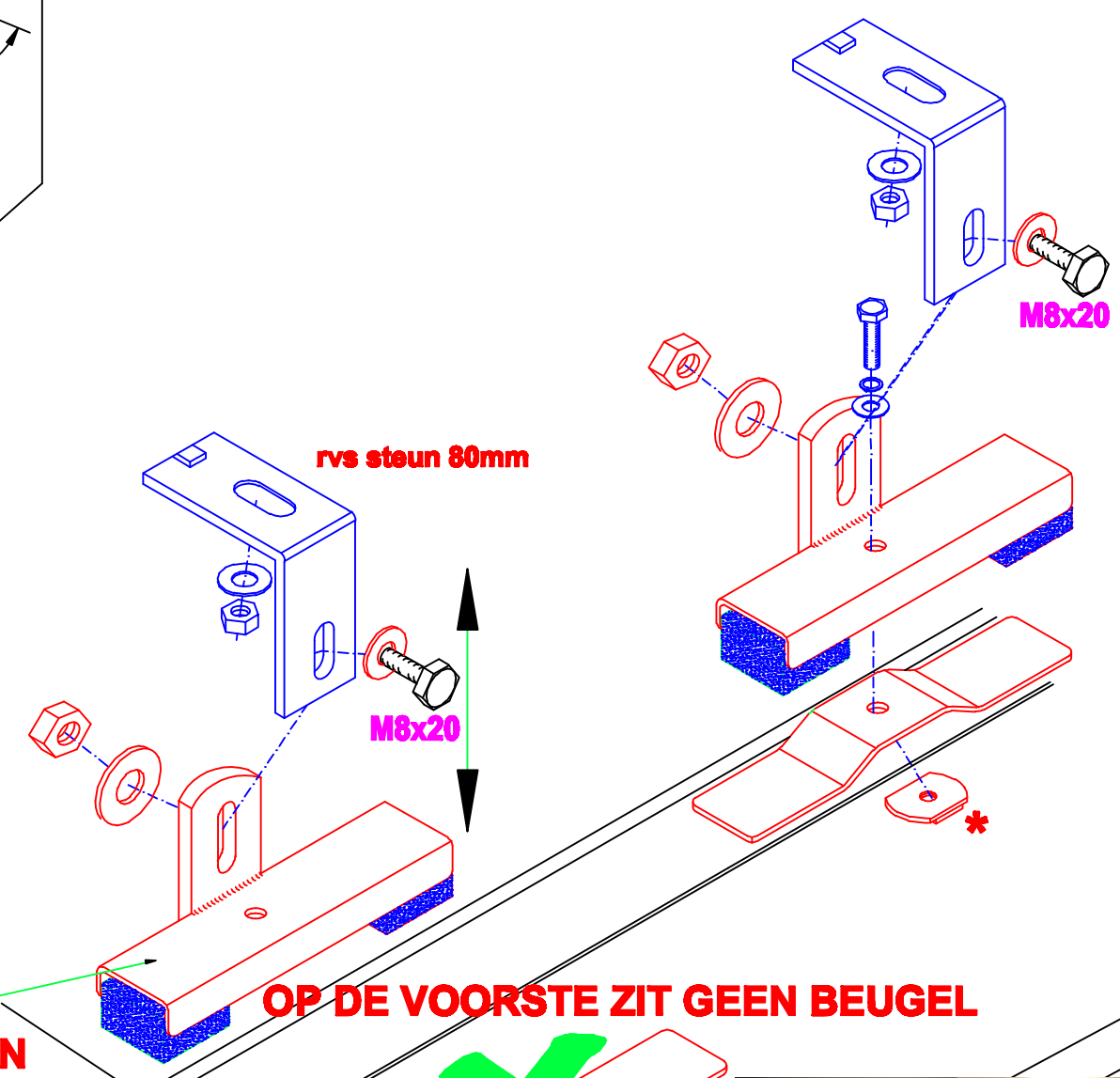

**P= ALS LAATSTE
 ONDER SPANNING ZETTEN
 ALLEEN AAN DE VOORKANT**

OP DE VOORSTE ZIT GEEN BEUGEL



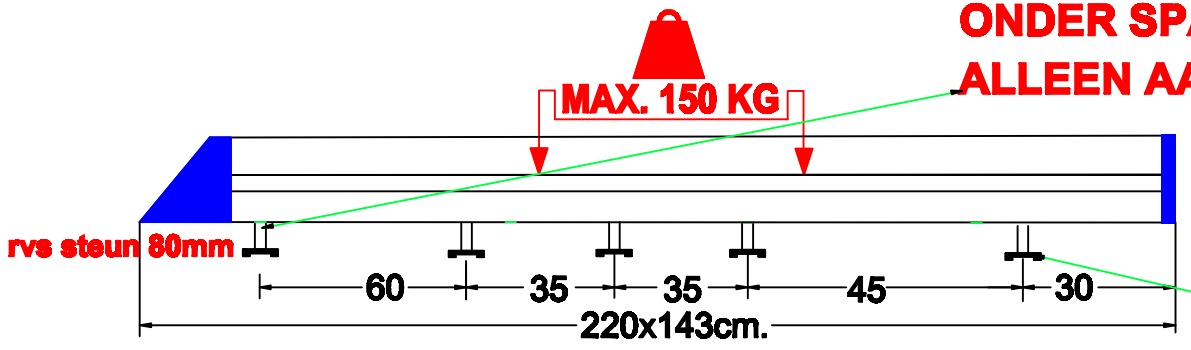

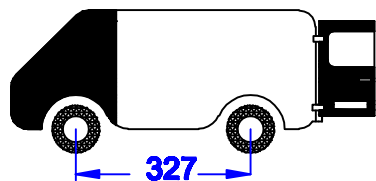

**ALS EERSTE ACHTERSTE
 STEUN VAST ZETTEN**

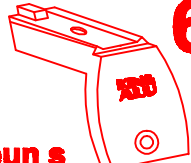
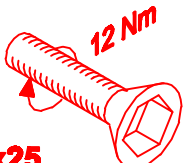
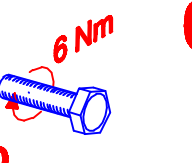
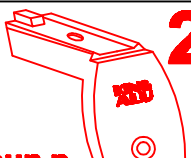

Citroën Jumpy TYPE M 2016
Peugeot Expert STANDAARD 2016
Toyota ProAce WORKER 2016

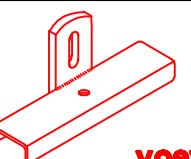

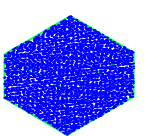
280x141cm. L2 H1

 6x	 8x 12 Nm	 6x 6 Nm
 2x	 16x	 6x
 8x	 16x	 6x
 16x		 *6x

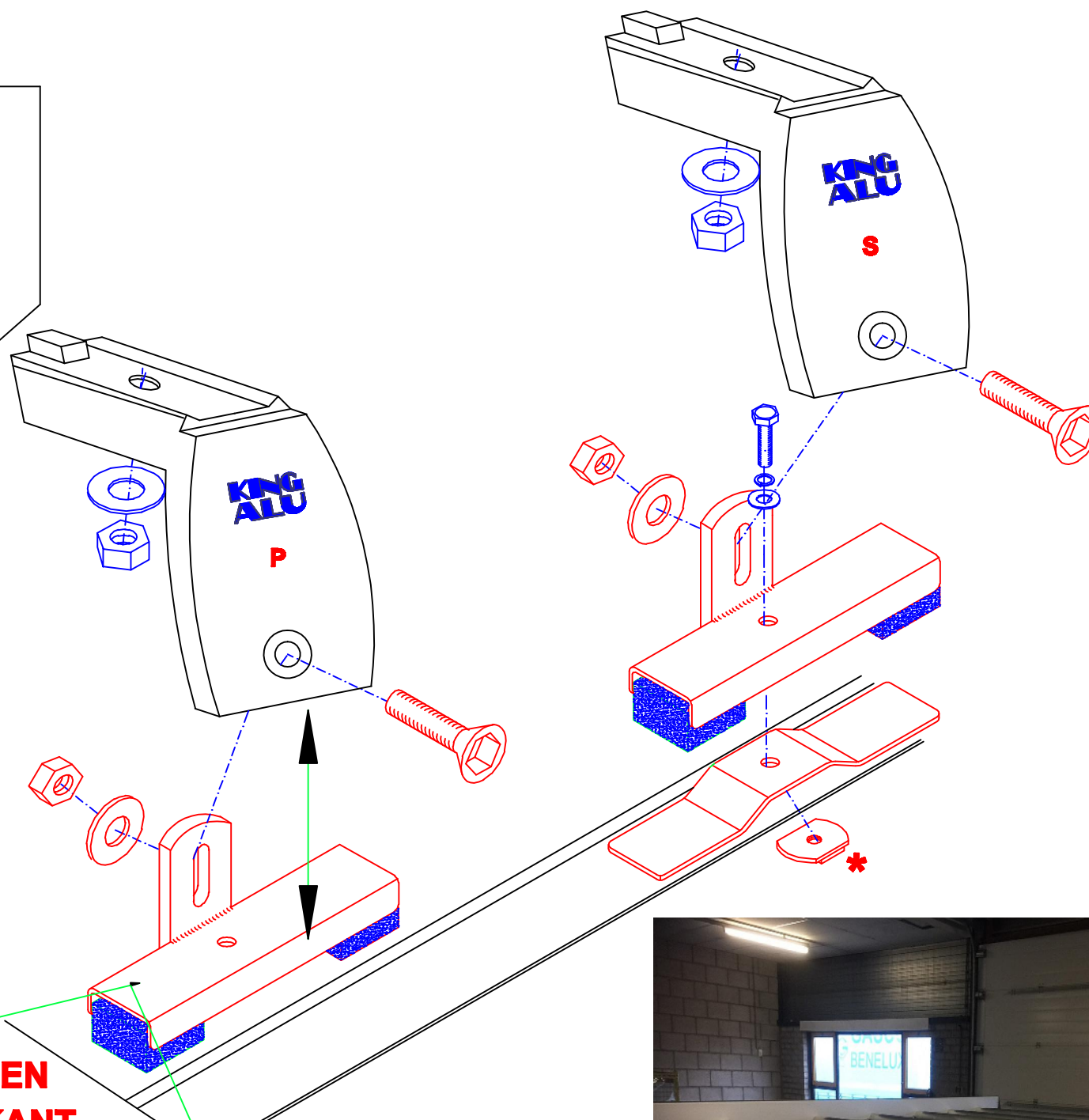

**P= ALS LAATSTE
 ONDER SPANNING ZETTEN
 ALLEEN AAN DE VOORKANT**

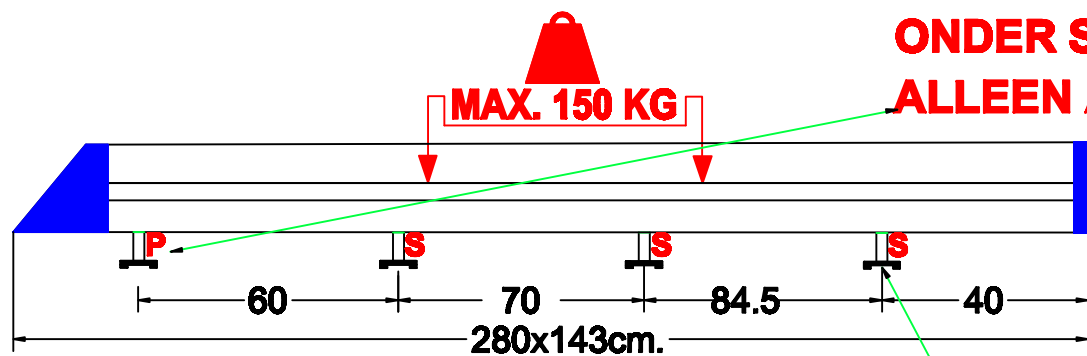

**ALS EERSTE ACHTERSTE
 STEUN VAST ZETTEN**









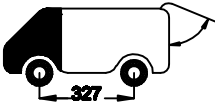



let op deze niet gebruiken

2806 ALUPEL2H1D / ALUCJL2H1D / ALUTPL2H1D 08/2017

Citroën Jumpy TYPE M 2016
Peugeot Expert STANDAARD 2016
Toyota ProAce WORKER 2016



280x141cm. L2 H1

 8x	 10x	 8x
 2x	 20x	 8x
 10x	 20x	 8x
 20x		 8x

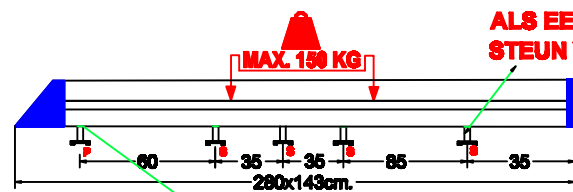

**ALS EERSTE ACHTERSTE
 STEUN VAST ZETTEN**

P=VOOR



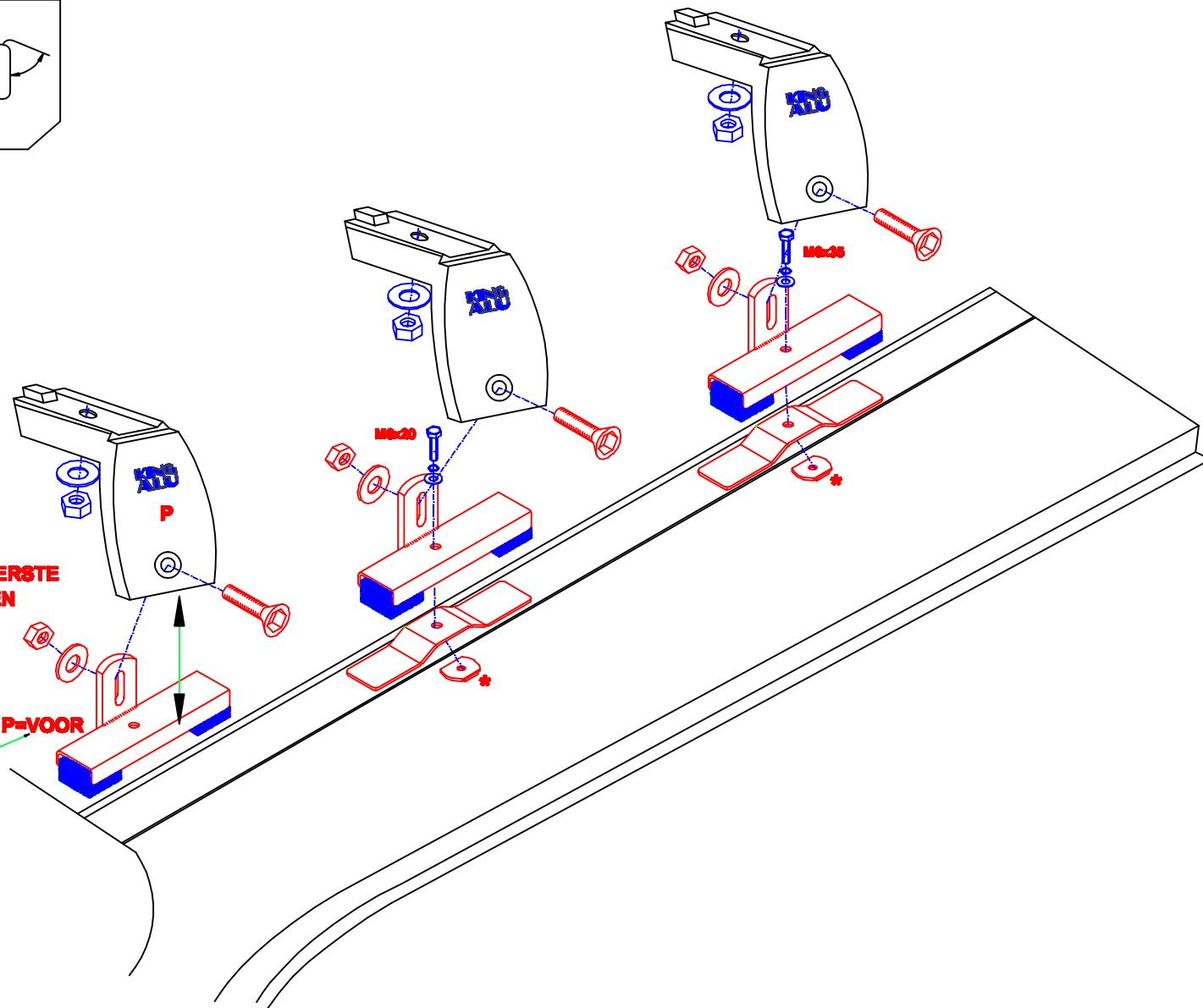



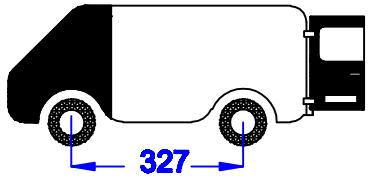

**P= ALS LAATSTE
 ONDER SPANNING ZETTEN
 ALLEEN AAN DE VOORKANT**

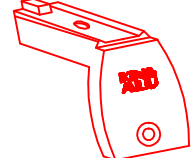

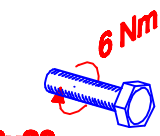
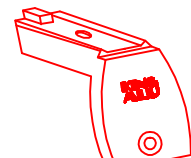
Citroën Jumpy
Peugeot Expert
Toyota ProAce
300x141cm. L3 H1

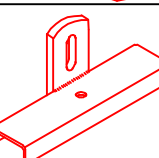
TYPE XL **2016**
STANDAARD **2016**
WORKER XL **2016**

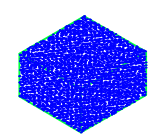

 8x	 10x	 8x
 2x	 20x	 8x
 10x	 20x	 8x
 20x		 8x

MONTAGEFILM KING-ALU IMPERIAAL

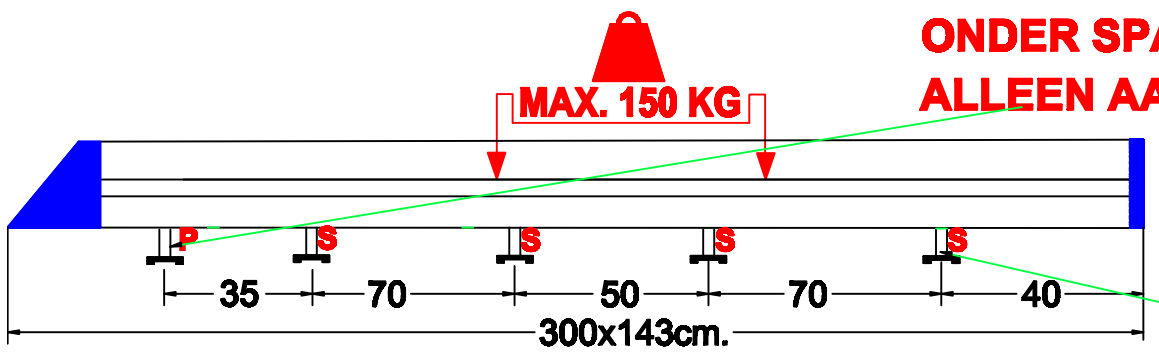
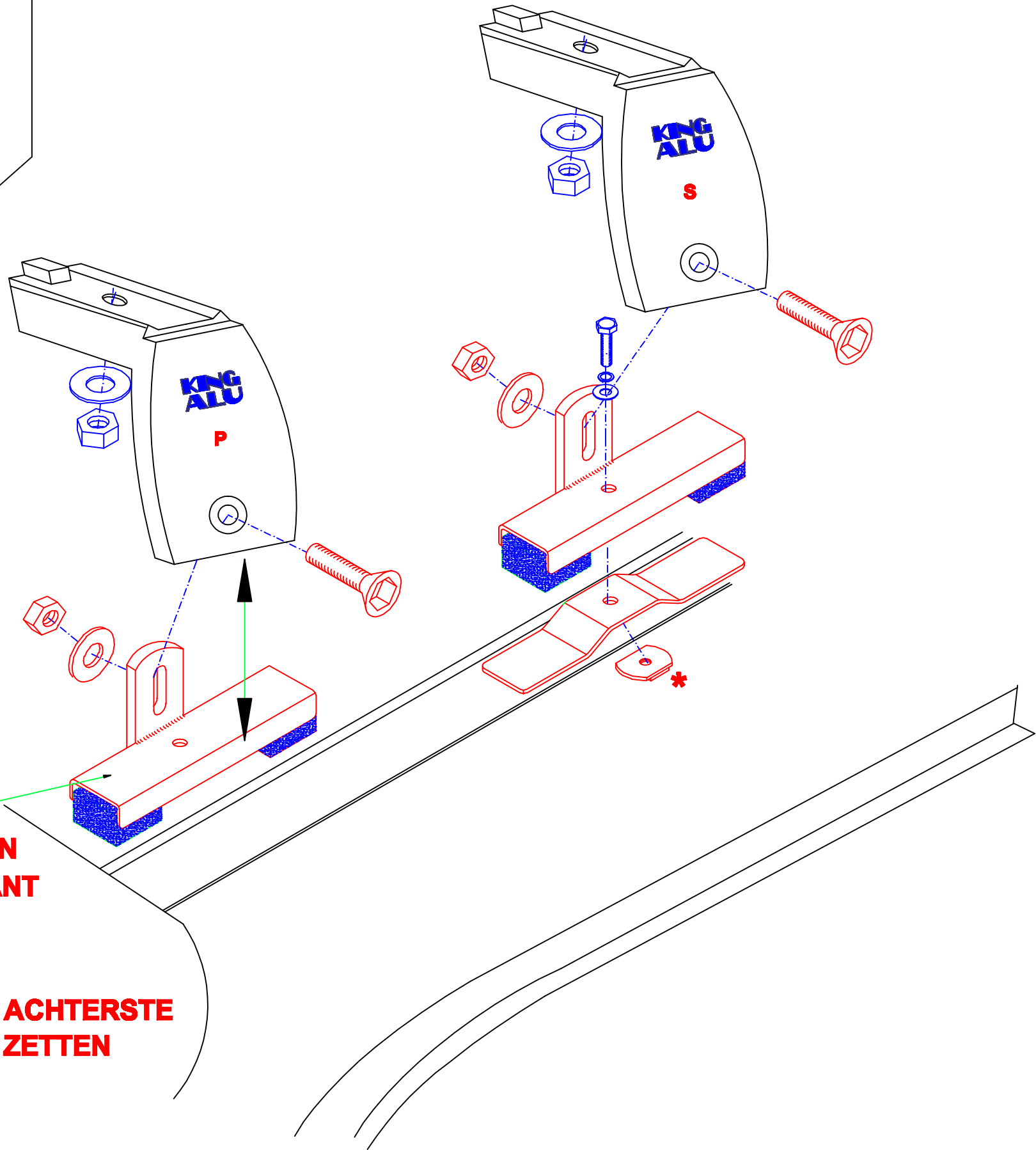

ALS EERSTE ACHTERSTE STEUN VAST ZETTEN

Citroën Jumpy	TYPE XL	2016	
Opel Vivaro	TYPE XL		
Peugeot Expert	LONG	2016	
Toyota ProAce	WORKER XL	2016	

300x141cm. L3 H1

8x	10x	10x
2x	20x	10x
10x	20x	10x
	10x	10x

KING PING
www.kingping.nl
info@kingping.nl

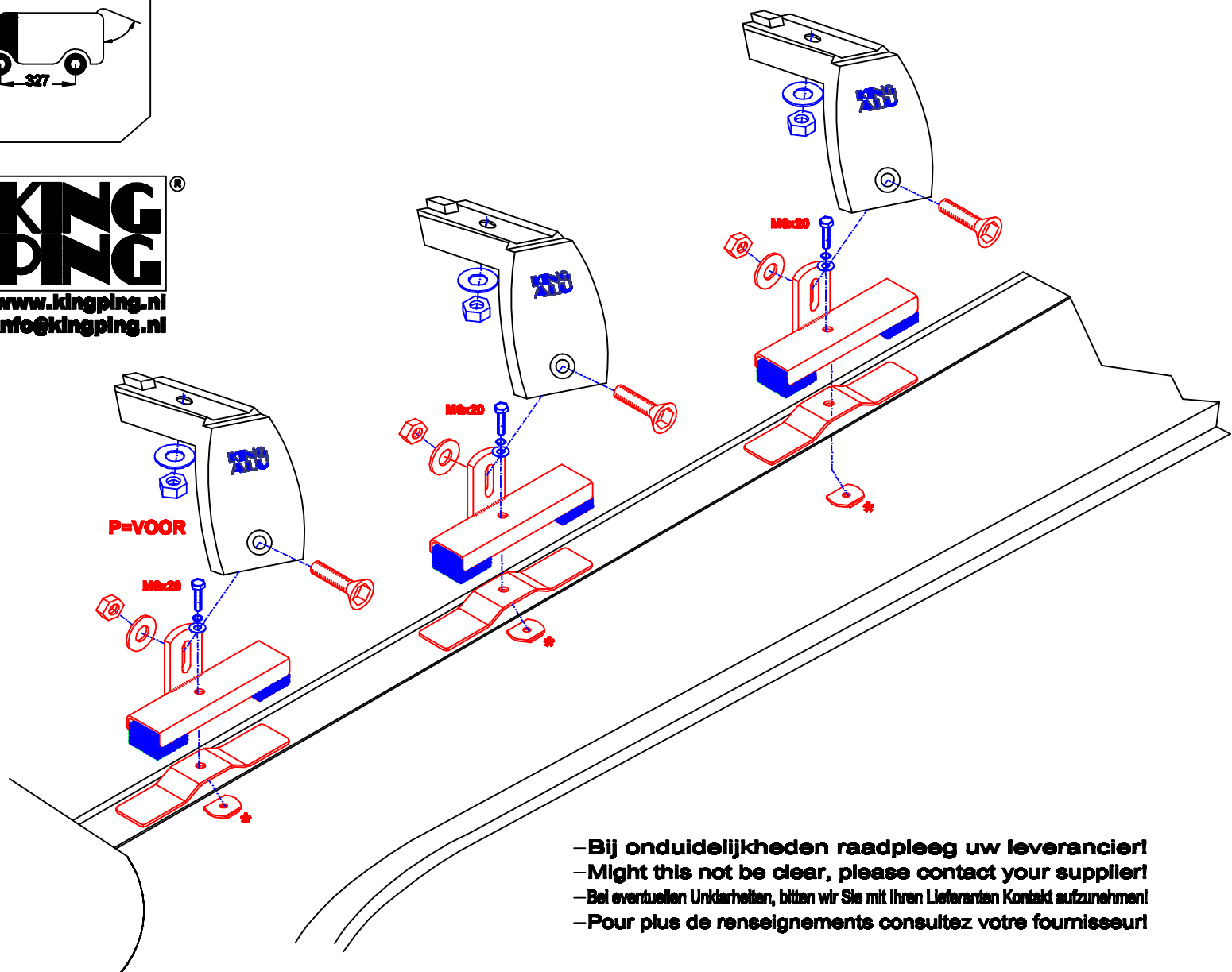
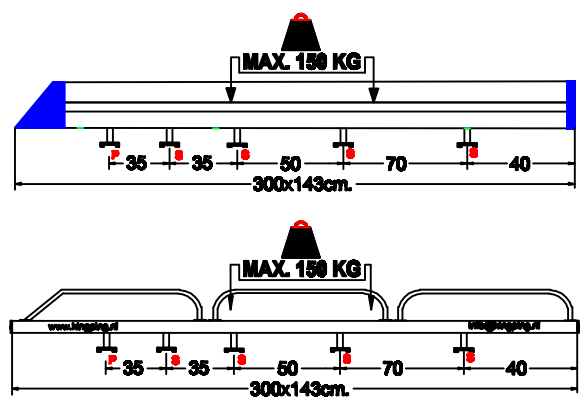

- Bij onduidelijkheden raadpleeg uw leverancier!
- Might this not be clear, please contact your supplier!
- Bei eventuellen Unklarheiten, bitten wir Sie mit Ihren Lieferanten Kontakt aufzunehmen!
- Pour plus de renseignements consultez votre fournisseur!