

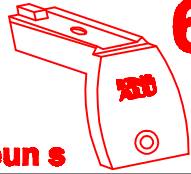

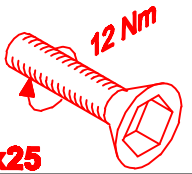

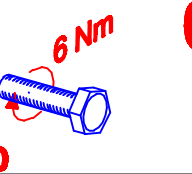
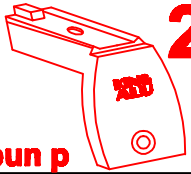

**Citroën Jumpy** TYPE M 2016  
**Peugeot Expert** STANDAARD 2016  
**Toyota ProAce** WORKER 2016

280x141cm. L2 H1

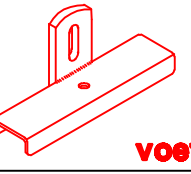

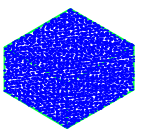
 <b>6x</b>	 <b>8x</b> 12 Nm	 <b>6x</b> 6 Nm
 <b>2x</b>	 <b>16x</b>	 <b>6x</b>
 <b>8x</b>	 <b>16x</b>	 <b>6x</b>
 <b>16x</b>		 <b>*6x</b>

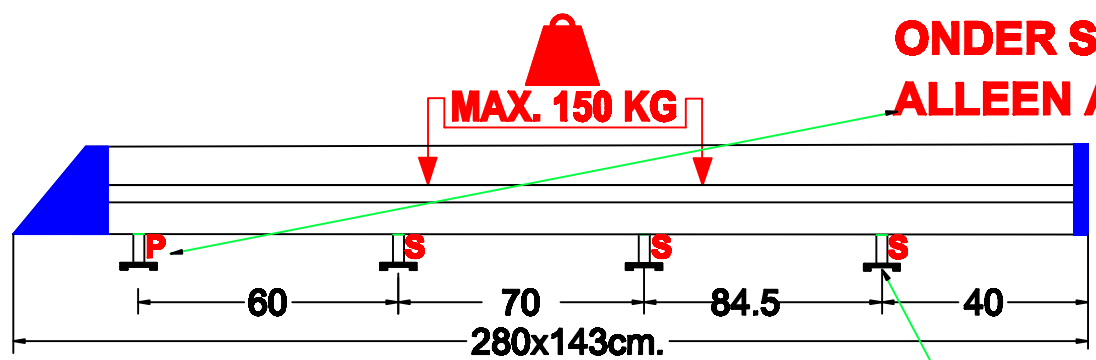
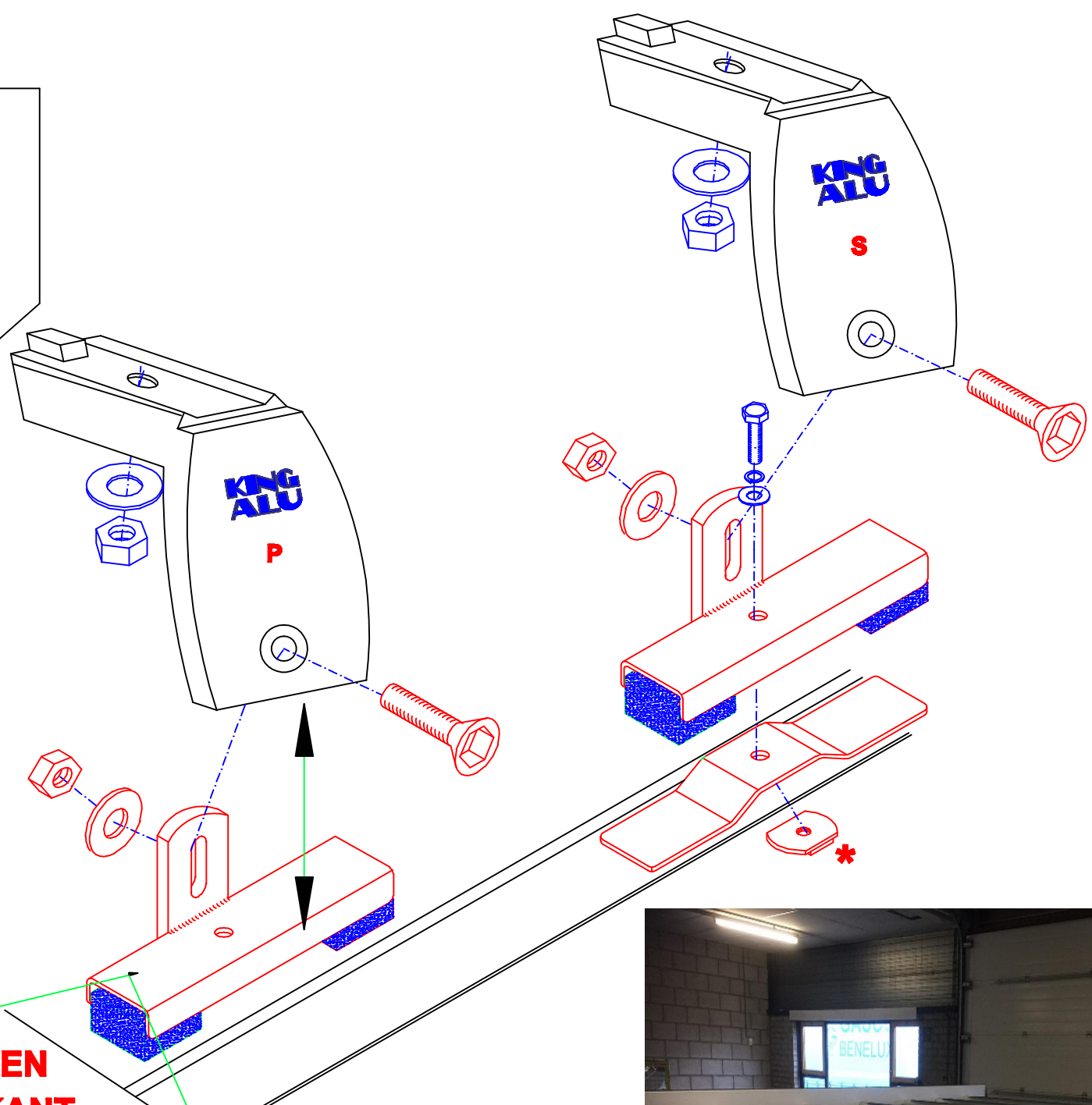

**P= ALS LAATSTE  
 ONDER SPANNING ZETTEN  
 ALLEEN AAN DE VOORKANT**

**ALS EERSTE ACHTERSTE  
 STEUN VAST ZETTEN**



2806 ALUPEL2H1D / ALUCJL2H1D / ALUTPL2H1D 08/2017







**let op deze niet gebruiken**

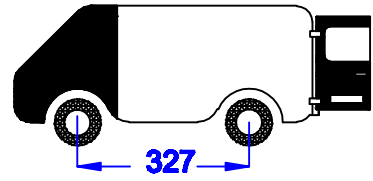

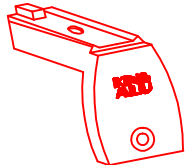
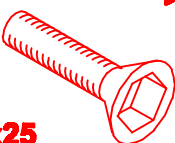
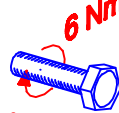
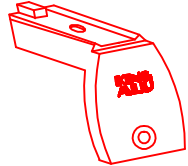
**Citroën Jumpy**  
**Peugeot Expert**  
**Toyota ProAce**  
**300x141cm. L3 H1**

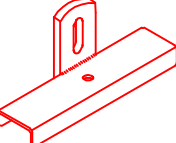
**TYPE XL**     **2016**  
**STANDAARD**   **2016**  
**WORKER XL**   **2016**

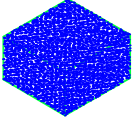

 <b>8x</b>	 <b>10x</b>	 <b>8x</b>
 <b>2x</b>	 <b>20x</b>	 <b>8x</b>
 <b>10x</b>	 <b>20x</b>	 <b>8x</b>
 <b>20x</b>		 <b>8x</b>

MONTAGEFILM KING-ALU IMPERIAAL

**P= ALS LAATSTE  
 ONDER SPANNING ZETTEN  
 ALLEEN AAN DE VOORKANT**

**ALS EERSTE ACHTERSTE  
 STEUN VAST ZETTEN**

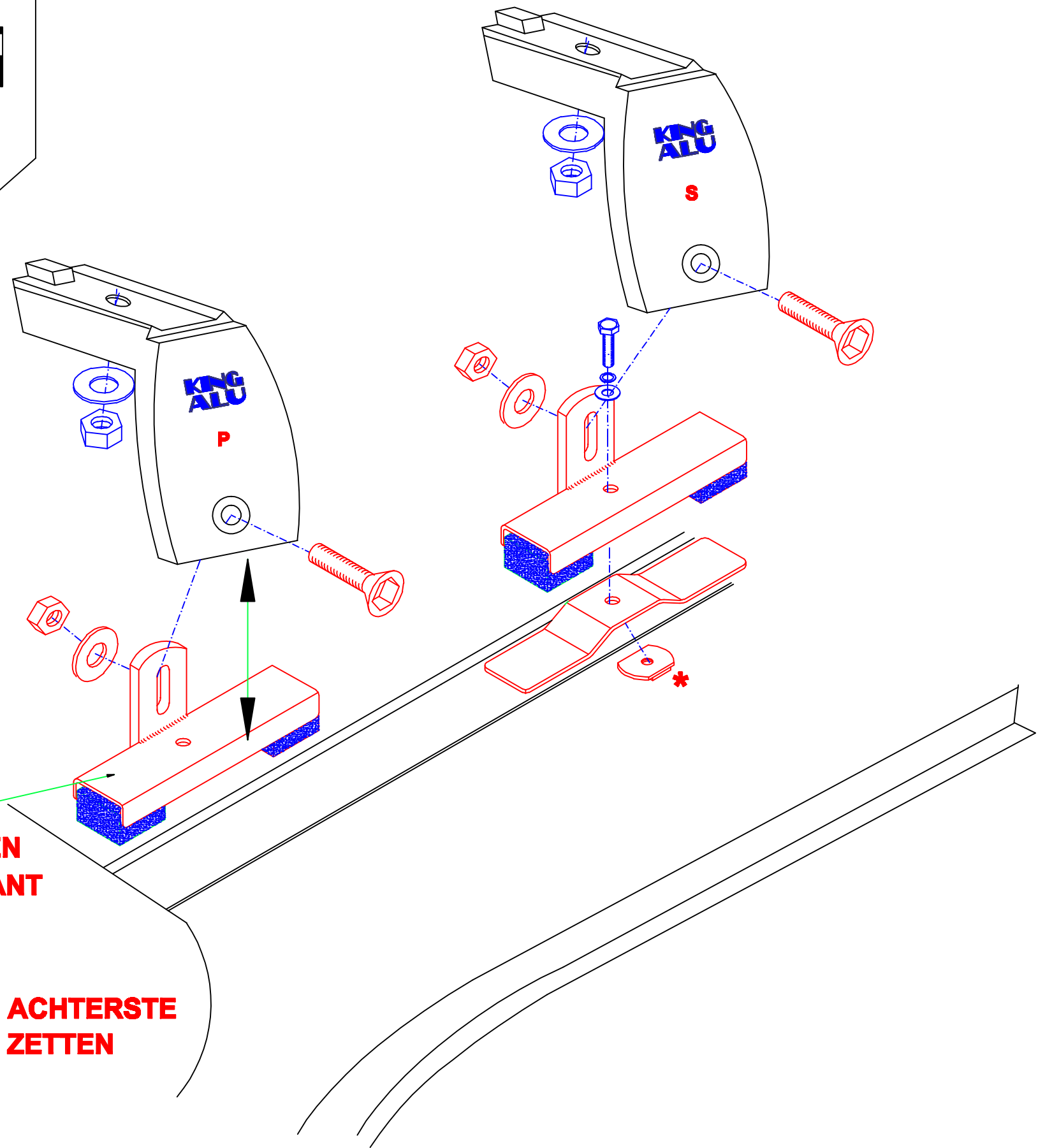
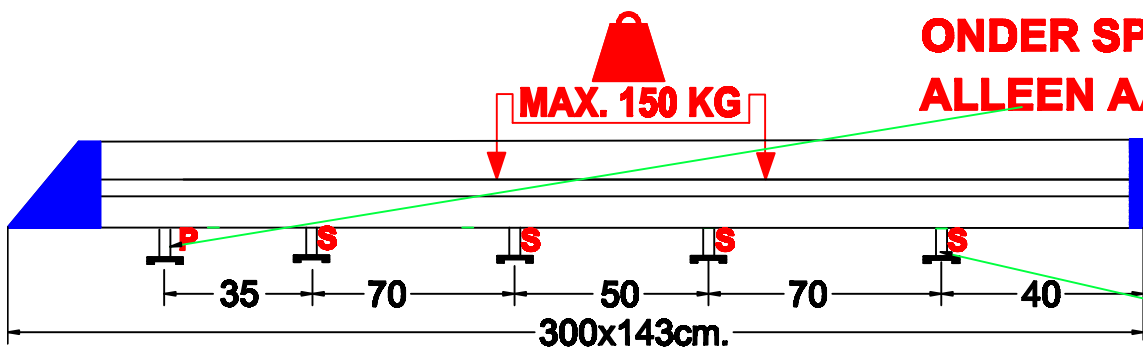

<b>Citroën Jumpy</b>	TYPE XL	2016	
<b>Opel Vivaro</b>	TYPE XL		
<b>Peugeot Expert</b>	LONG	2016	
<b>Toyota ProAce</b>	WORKER XL	2016	

300x141cm. L3 H1

8x	10x	10x
2x	20x	10x
10x	20x	10x
	10x	

**KING PING**  
[www.kingping.nl](http://www.kingping.nl)  
[info@kingping.nl](mailto:info@kingping.nl)

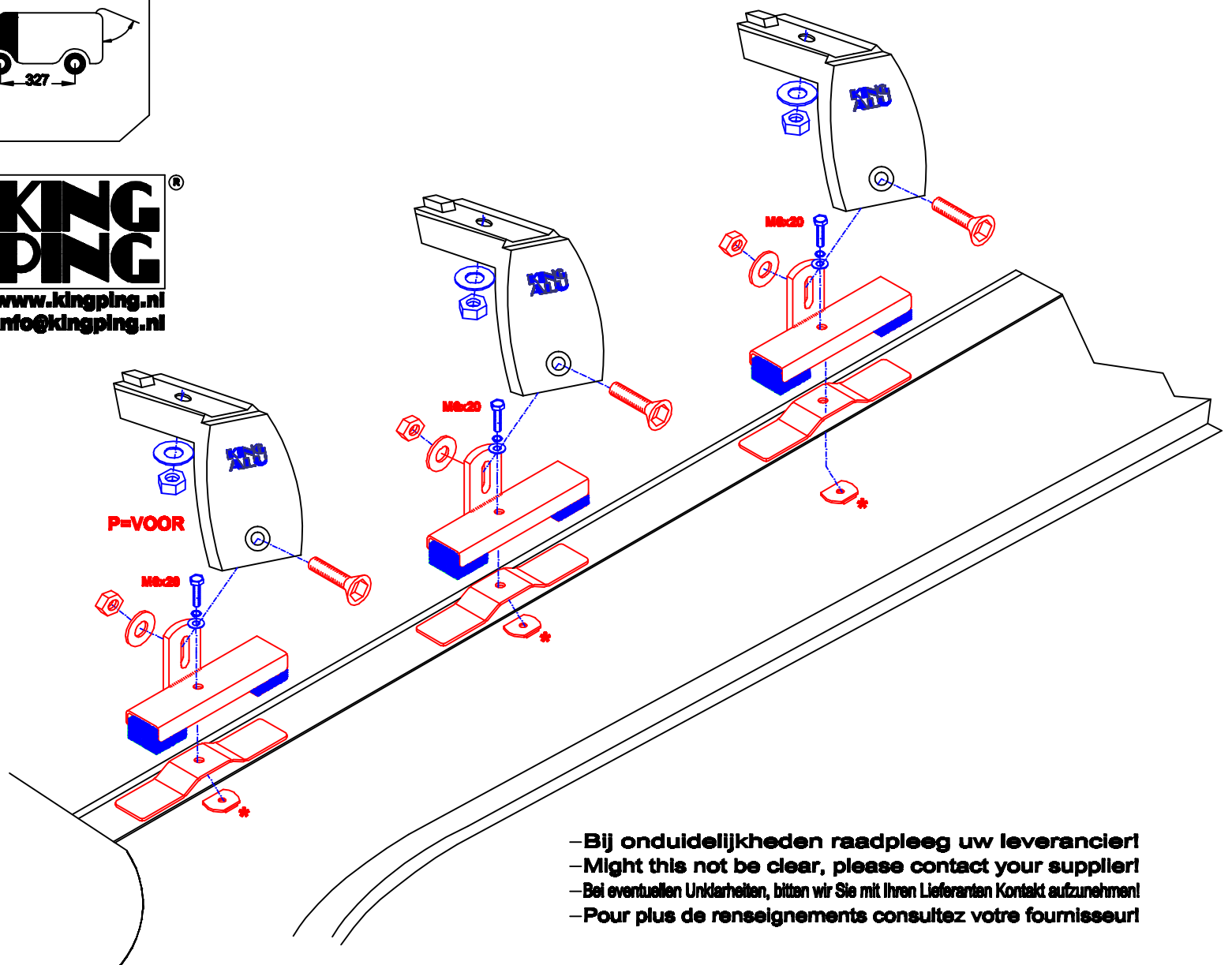
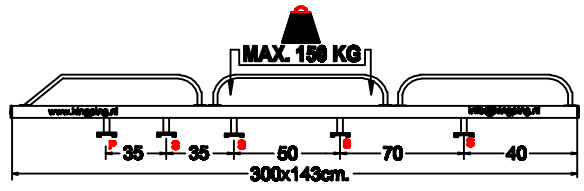
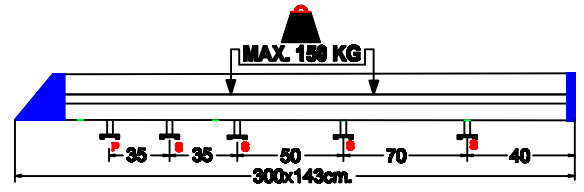

- Bij onduidelijkheden raadpleeg uw leverancier!
- Might this not be clear, please contact your supplier!
- Bei eventuellen Unklarheiten, bitten wir Sie mit Ihren Lieferanten Kontakt aufzunehmen!
- Pour plus de renseignements consultez votre fournisseur!